



Ersatzteile passend für: GIORIK

Ersatzteile passend für Heißluftöfen und Combidämpfer



Ersatzteile passend für Klein- und Einzelgeräte



G.E.V. Großküchen-Ersatzteil-Vertrieb GmbH

Robert-Koch-Straße 3a
82152 Planegg/München
Deutschland

Telefon: +49 (0)89 745572-0
Telefax: +49 (0)89 745572-82

info@gev-online.de
www.gev-online.de



GEV GmbH Ersatzteile und Zubehör

Kanalstrasse 14
5745 Safenwil
Schweiz

Telefon: +41 (0)62 797 87 70
Telefax: +41 (0)62 797 25 07

info@gev.ch
www.gev.ch

Members of the GEV GROUP

Komponenten (Bedienungsblenden)



Abb.	Bestell-Nr.	Beschreibung	Gerätetyp	Vergleichs-Nr.
1	346341	Wahlschalter	EDM_ GDM_	6030030
2	346342	Wahlschalter	EVM_ GVM_	6030031
3	111738	Knebel	Universal	2012261



Abb.	Bestell-Nr.	Beschreibung	Gerätetyp	Vergleichs-Nr.
1	350074	Timer	EDM_	6032047
2	380015	Energeregler	GDM_	6031023
3	300187	Potentiometer	GVM_	6010097



Abb.	Bestell-Nr.	Beschreibung	Gerätetyp	Vergleichs-Nr.
1	401166	Display	EDM_	6010095
2	401167	Elektronik (Thermostat)	GDM_ EVM_ GVM_	6010096



Abb.	Bestell-Nr.	Beschreibung	Gerätetyp	Vergleichs-Nr.
1	346343	Schutzkappe	EDM_	6032021
2	346344	Schutzkappenring	GDM_	6032022
3	346345	Taster weiß	EVM_	6032020
4	346346	Taster rot	GDM_ GVM_	6032038

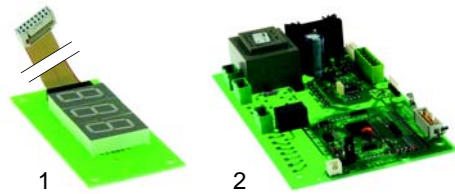

Abb.	Bestell-Nr.	Beschreibung	Gerätetyp	Vergleichs-Nr.
1	401168	Platine	EDE_	6010100
2	401169	Entcoder	GDE_	6010102
3	111739	Knebel	EVE_	6012260
4	401170	Platine	GVE_	6010101

Komponenten (Elektro)



Abb.	Bestell-Nr.	Beschreibung	Gerätetyp	Ver.-Nr.
1	401171	Platine Umsteuerung	Universal	6010084
2	401172	Platine Danpfgenerator	EVE_ GVE_	6010093
3	401173	Platine Niveauregelung	EVM_ GVM_	6041043

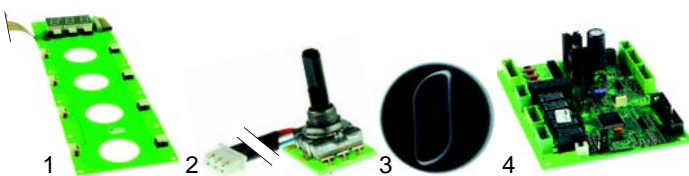

Abb.	Bestell-Nr.	Beschreibung	Gerätetyp	Vergleichs-Nr.
1	350076	Summer	EDM_	6010090
2	380606	Zeitrelais	GDM_	6042056
3	350077	Summer	EDE_	6010103
4	401174	Transformator	GDE_ EVE	6010079



Abb.	Bestell-Nr.	Beschreibung	Gerätetyp	Vergleichs-Nr.
1	380608	Zeitrelais	EVM_	6042049
2	380607	Zeitrelais	GVM_	6042054
3	380487	Socket	EVE_	6040015
4	380488	Relais	GVE_	6041009

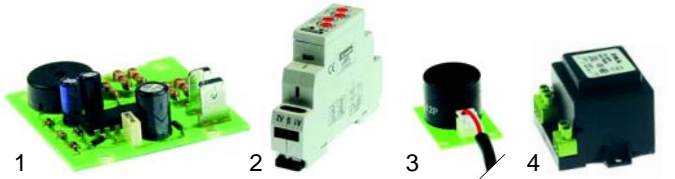

Abb.	Best.-Nr.	Beschreibung	Gerätetyp	Ver.-Nr.
1	346347	Mikroschalter		6043088
2	375628	Sich.-thermostat, 350°C	Universal	6010008
3	375277	Sich.-thermostat, 150°C	EVM_ EVE_	6010002



Pos.	Bestell-Nr.	Beschreibung	Gerätetyp	Vergleichs-Nr.
1	601080	Lüfter	Universal	6033175

G

Passend für Giorik



Abb.	Bestell-Nr.	Beschreibung	Gerätetyp	Ver.-Nr.
1	359337	Lampenfassung		6063075
2	359338	Glas		6063077
3	359599	Halogenlampe, 20W/12V		6061054
4	401175	Transformator		6041065



Abb.	Best.-Nr.	Beschreibung	Gerätetyp	Ver.-Nr.
1	374017	Magnetventil 1fach	EDM_, GDM_ EDE_, GDE_	6042070
2	374021	Magnetventil 2fach	EVM_, GVM_	6042071
3	370352	Magnetventil 1/2Zoll	EVE_, GVE_	6042075
4	371264	Reduzierung 0,25L/min. (Ausgang)	EVM_, GVM_ EVE_, GVE_	6042095
5	371265	Reduzierung 0,25L/min. (Eingang)		6042097



Abb.	Bestell-Nr.	Beschreibung	Gerätetyp	Vergl.-Nr.
1	418086	8400W/230V	__0061	6002001
2	418087	15000W/230V	__0101, __0201	6002125



Abb.	Best.-Nr.	Beschreibung	Gerätetyp	V.-Nr.
1	418088	25000W/400V	__0102	6002121
2	418084	7600W/230V	__V__0061, __V__0101, __V__0102	6003290
3	418085	10000W/230V	__V__201	6003295
4	550548	Dichtung	Universal	2005173
5	510409	O-Ring	-	



Abb.	Bestell-Nr.	Beschreibung	Gerätetyp	V.-Nr.
1	500640	Motor 0,25PS	__0061	6032122
2	500641	Motor 1,0PS	__DM0101, __VM0101, __DM0102 (bis 02.04) __VM0102 (bis 02.04)	6033155



Abb.	Bestell-Nr.	Beschreibung	Gerätetyp	V.-Nr.
1	500642	Motor 1,0PS	__DE0101, __VE0101, __DE0102 (bis 01.04) __VE0102 (bis 01.04)	6033145
2	500643	Motor 1,0PS	__0102 (ab 02.04)	6034348



Abb.	Bestell-Nr.	Beschreibung	Gerätetyp	Vergl.-Nr.
1	601202	Lüfterrad, Ø180mm	__0061	0591006
2	601203	Lüfterrad, Ø310mm	__0101	5901010
3	601204	Lüfterrad, Ø350mm	__0102	5901022

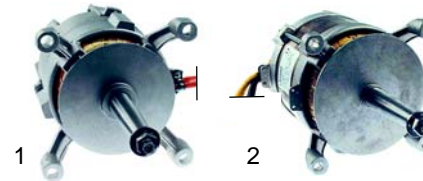

Abb.	Bestell-Nr.	Beschreibung	Gerätetyp	Vergl.-Nr.
1	550549	Dichtung Motor	__0061	7070150
2	550550	Dichtung Motor	__0101, __0102, __0201	7070151

Komponenten (Gas)

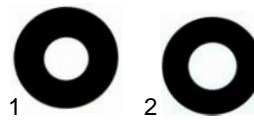

Abb.	Bestell-Nr.	Beschreibung	Gerätetyp	Vergl.-Nr.
1	105774	Brenner Heißluft	__D0061,	7090102
2	105775	Brenner Heißluft	__0101, __0102, __0201	7090101
3	105776	Brenner Heißluft	__V__0061	7090100
4	105774	Brenner boiler	Universal	7090102

Komponenten (Mechanik)



Abb.	Bestell-Nr.	Beschreibung	Gerätetyp	Vergleichs-Nr.
1	101881	Tandemventil		7020080
2	101685	Feurungsautomat		7020085



Abb.	Bestell-Nr.	Beschreibung	Gerätetyp	Vergleichs-Nr.
1	690584	Türgriff		2013218
2	690585	Buchse		201212
3	690040	Kloben		5900122



Abb.	Best.-Nr.	Beschreibung	Gerätetyp	Ver.-Nr.
1	102331	Zündelectrode	__0061 (Heißluft)	2012109
2	102332	Überwachungselectrode	__0101 (Boiler) __0102 (Boiler) __0201 (Boiler)	2012108
3	102333	Zündelectrode	__0101 (Heißluft)	2012111
4	102334	Überwachungselectrode	__0102 (Heißluft) __0201 (Heißluft) __0061 (Boiler)	2012110



Abb.	Bestell-Nr.	Beschreibung	Gerätetyp	Vergleichs-Nr.
1	690042	Getriebe		
2	690041	Riegelstück		
3	690046	Getriebekonsolle		

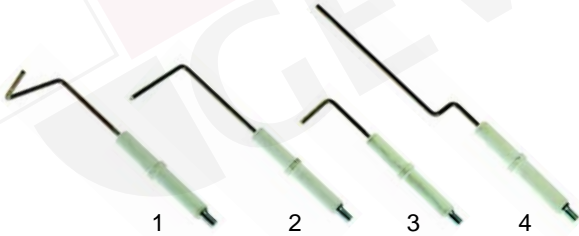

ohne Abb.

Abb.	Bestell-Nr.	Beschreibung	Gerätetyp	Ver.-Nr.
1	900439	Türdichtung, Meterware		7070166
2	900440	Fensterdichtung, Meterware		7070167

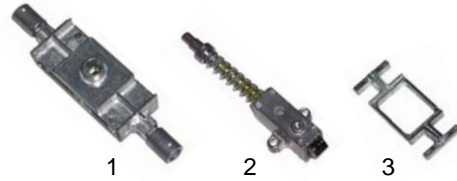
Salamander (Gas)



Abb.	Bestell-Nr.	Beschreibung	Gerätetyp	Vergleichs-Nr.
1	105524	Brenner	SG608	2001246
2	105525	Brenner	SG520	2103520
3	105526	Keramikplatte		7090073



Abb.	Bestell-Nr.	Beschreibung	Gerätetyp	Vergl.-Nr.
1	102041	Thermoelement, 600mm	SG608,	6010055
2	101086	Gashahn	SG520	7060012
3	111505	Knebel		5900192

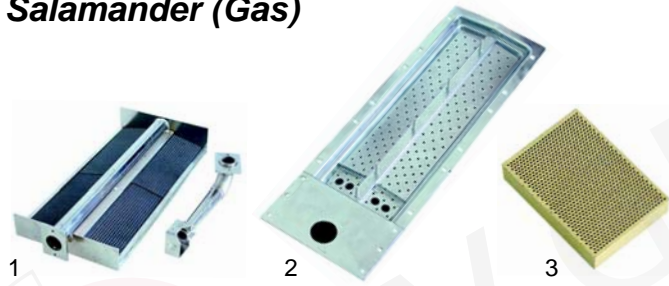

Abb.	Bestell-Nr.	Beschreibung	Gerätetyp	Vergleichs-Nr.
1	100046	Zündbrenner		7090022
2	100706	Zündkerze	SG608	6010046
3	100140	Zündkabel		6050051
4	100013	Piezozünder		6010047

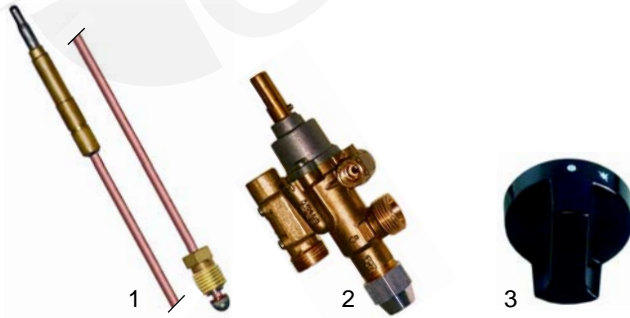

Abb.	Bestell-Nr.	Beschreibung	Gerätetyp	Vergleichs-Nr.
1	100867	Zündbrenner		7090027
2	100701	Zündkerze	SG520	6010062
3	100019	Zündkabel		6050610
4	100013	Piezozünder		6010047

Salamander (Elektro)

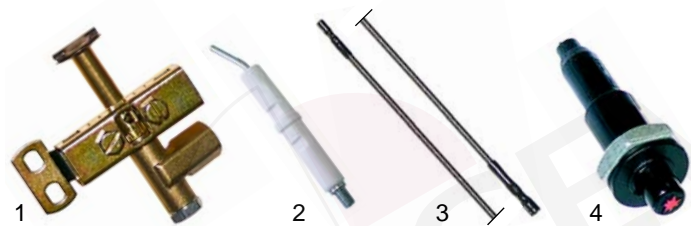

Abb.	Bestell-Nr.	Beschreibung	Gerätetyp	Vergl.-Nr.
1	415659	2185W/230V	S504, S505, SR514	6001067
2	415660	3060W/230V	S505R	6001068
3	415215	2570W/230V	S510	6002021
3	415623	3100W/230V	S510S	6003022



Abb.	Bestell-Nr.	Beschreibung	Gerätetyp	Vergleichs-Nr.
1	415220	2730W/230V	S511	6002066
1	415209	3000W/230V	S511S	6003052
2	415450	650W/230V	SR512R	6002058
2	416820	930W/230V	SR512	6001071
3	415213	3300W/230V	SE520	6001133
3	415214	3300W/400V	SE520	6003133



Abb.	Bestell-Nr.	Beschreibung	Gerätetyp	V.-Nr.
1	380015	Energieregler	S504, S505, S505R,	6031023
2	111506	Knebel Markierung	S510, S510S, S511,	2002915
3	111507	Knebel Nullstrich	S511S, SR512R,	2001390
			SR512, SR514, SE520	

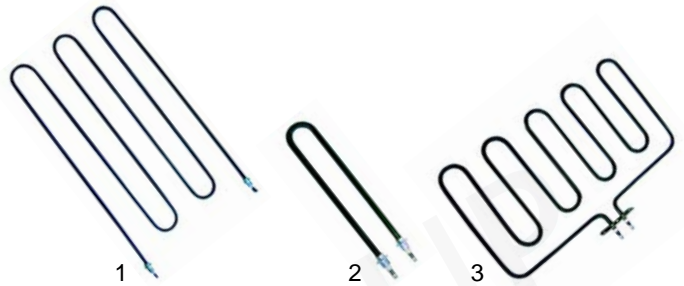

Abb.	Bestell-Nr.	Beschreibung	Gerätetyp	V.-Nr.
1	359430	Signallampe/klar	S504, S505, S505R,	6061067
2	359225	Einsteckfassung	S510, S510S, S511,	6061069
			S511S	
3	359431	Signallampe/grün	SR512R, SR512,	6061068
4	359126	Einsteckfassung	SR514, SE520	6061070

Friteusen (Gas)



Abb.	Bestell-Nr.	Beschreibung	Gerätetyp	Ver.-Nr.
1	416001	1500W/230V	SH505N, SH510,	6001066
2	400736	Elektroniktastatur	SH511, SH520GM,	6010083
3	379054	Transformator	SH520	6010086



Abb.	Best.-Nr.	Beschreibung	Gerätetyp	Ver.-Nr.
1	300129	Schalter	SH505N	6030007
2	300139	Schalter	SH510, SH511,	6030012
3	111508	Knebel	SH520GM, SH520G	2006823

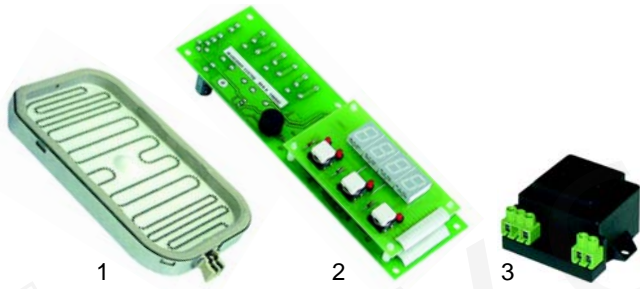

Abb.	Bestell-Nr.	Beschreibung	Gerätetyp	Ver.-Nr.
1	300146	Potentiometer	SH505N, SH510,	6010076
2	111508	Knebel	SH511, SH520GM,	2006823
3	380379	Relais	SH520	6041013

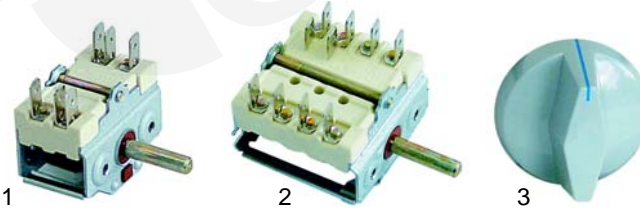

Abb.	B.-Nr.	Beschreibung	Gerätetyp	V.-Nr.
1	400737	Frontfolie	SH505N	2012426
2	400738	Frontfolie	SH510	2012423
3	400739	Frontfolie	SH511, SH520GN, SH520G	2012425

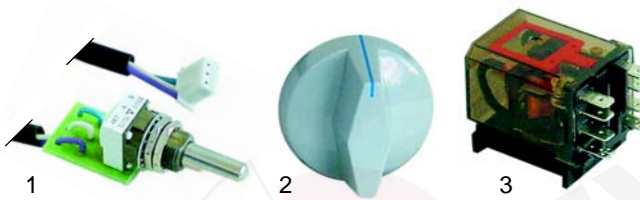

Abb.	B.-Nr.	Beschreibung	Gerätetyp	Ver.-Nr.
1	105527	Brenner (links/einzeln)	FG07L/13L/17L,	2001230
2	105528	Brenner (rechts/mittig)	FG207L/213L/217L,	2001231
3	105529	Brenner	FG07CL/17CL,	2112970
			FG213CL/217CL	

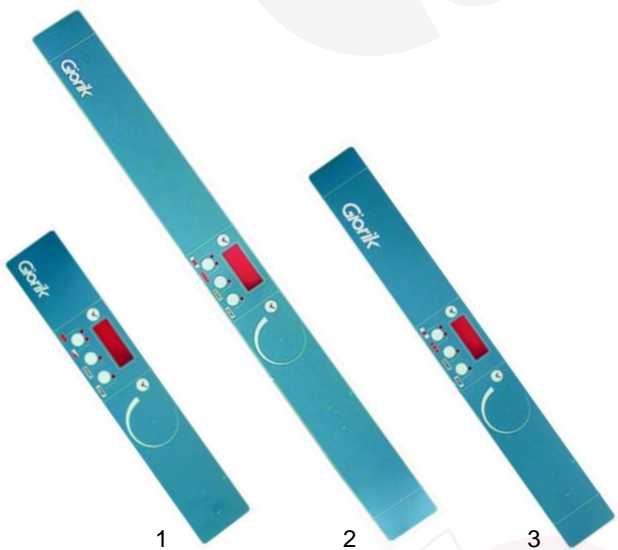

Abb.	B.-Nr.	Beschreibung	Gerätetyp	Ver.-Nr.
1	105530	Brenner (links)	13FG, 17FG, 213FG,	2112968
2	105531	Brenner (rechts)	217FG, 917FG,	2112967
3	105532	Brenner (mittig)	934FG, 17FG-C,	2112968
			213FG-C, 217FG-C	

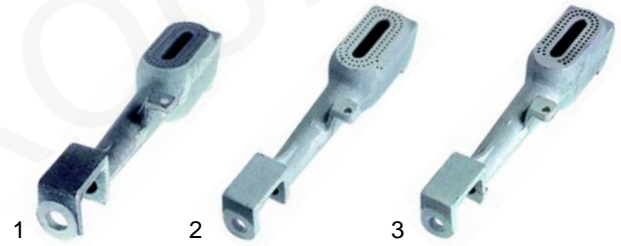

Abb.	B.-Nr.	Beschreibung	Gerätetyp	Ver.-Nr.
1	101162	Novasitregler	13FG, 17FG, 207FG,	1020070
			213FG, 217FG, 917FG,	
2	102041	Thermoelement 600mm	927FG, 934FG, FG70CL/	6010055
			17CL/213CL, FG217CL,	
3	101002	Zündgruppe	17FG-C, 213FG-C,	6041059
			217FG-C	

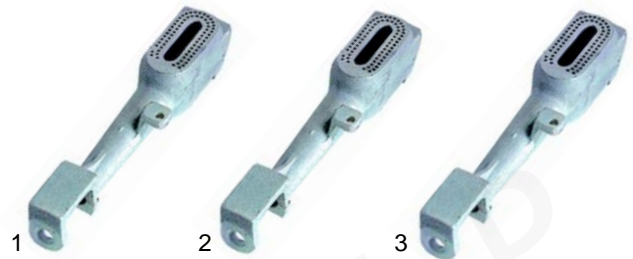

Abb.	B.-Nr.	Beschreibung	Gerätetyp	Ver.-Nr.
1	100106	Zündbrenner	13FG, 17FG, 207FG,	7090023
			213FG, 217FG, 917FG,	
2	100706	Zündkerze	927FG, 934FG, 17FG-C,	6010046
			213FG-C, 217FG-C	
3	100140	Zündkabel		6050051

G

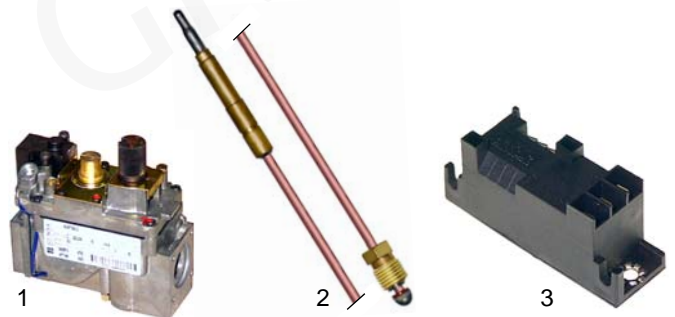
Passend für Giorik



Abb.	Bestell-Nr.	Beschreibung	Gerätetyp	Ver.-Nr.
1	100046	Zündbrenner		7090022
2	100706	Zündkerze	FG07CL/17CL,	6010046
3	100140	Zündkabel	FG213CL, FG217CL	6050051



Abb.	B.-Nr.	Beschreibung	Gerätetyp	V.-Nr.
1	375261	Thermostat		6010005
2	300001	Vorsatzschalter	13FG, 17FG, 207FG,	6030015
3	111509	Knebel	217FG, 917FG, 923FG,	2008672
4	375376	Sicherheitsthermostat	934FG	2011140



Abb.	Bestell-Nr.	Beschreibung	Gerätetyp	Ver.-Nr.
1	379459	Temperaturregler		6011142
2	693124	Frontfolie	FG07CL/17CL,	2007069
3	379462	Fühler	FG213CL, FG217CL	6000106

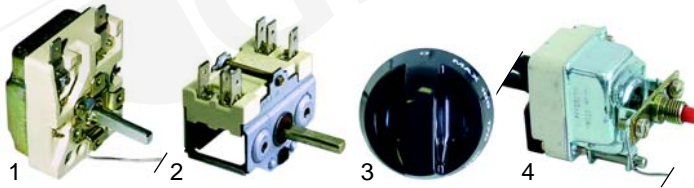

Abb.	Bestell-Nr.	Beschreibung	Gerätetyp	Ver.-Nr.
1	300129	Schalter	FG07CL/17CL,	6030007
2	111508	Knebel	FG213CL,	2006823
3	375376	Sicherheitsthermostat	FG217CL	2001046

Friteusen (Elektro)

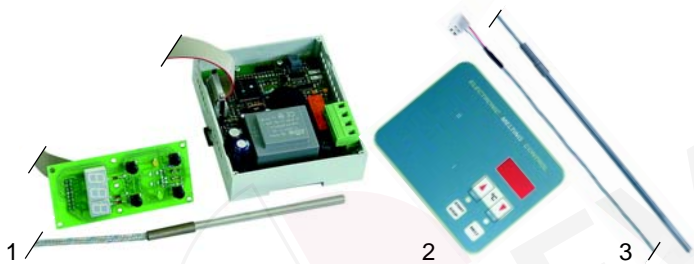

Abb.	B.-Nr.	Beschreibung	Gerätetyp	Ver.-Nr.
1	416063	6800W/3x230V	F10L/210L, F10CL/210CL	6002136
2	416070	10200W/3x230V	F15L/215L, F15CL/215CL	6002137
3	416059	15000W/3x230V	F20L/220L, F20CL/220CL	6002138



Abb.	B.-Nr.	Beschreibung	Gerätetyp	Ver.-Nr.
1	416824	7000W/3x230V	210FE, 922FE, 210FE-C	6002150
2	416825	12000W/3x230V	15FE, 215FE, 15FE-C,	6002151
3	416826	16500W/3x230V	20FE, 220FE, 920FE,	6002152
			940FE, 20FE-C, 215FE-C	



Abb.	Bestell-Nr.	Beschreibung	Gerätetyp	Vergleichs-Nr.
1	532500	O-Ring		6090145
2	532501	O-Ring	Universal	6090144
3	514248	Griff		2001110



Abb.	Bestell-Nr.	Beschreibung	Gerätetyp	Ver.-Nr.
1	375261	Thermostat		6010005
2	300166	Vorsatzschalter	F10L, F15L, F210L,	6030019
3	111509	Knebel	F215L, 210FE, 922FE	2008672

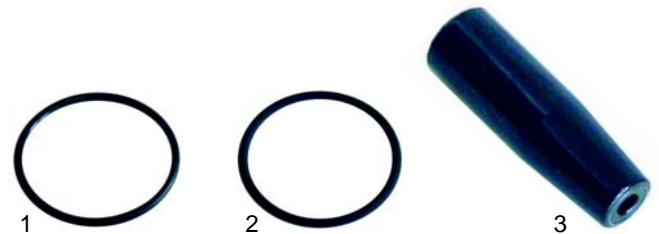

Abb.	Bestell-Nr.	Beschreibung	Gerätetyp	Ver.-Nr.
1	375261	Thermostat		6010005
2	111509	Knebel	F20L, F220L, 15FE, 20FE, 215FE, 220FE, 920FE, 940FE	2008672
3	345817	Schalter		6030003
4	111511	Knebel		2008673

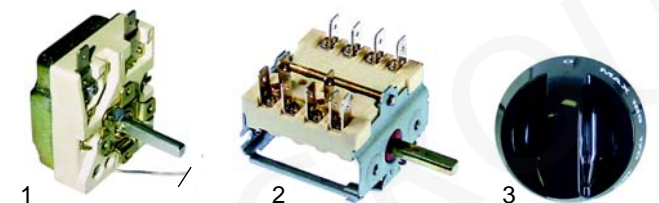

Abb.	Bestell-Nr.	Beschreibung	Gerätetyp	Ver.-Nr.
1	300139	Schalter	F10CL, F15CL, F210CL, F215CL, 210FE-C	6030012
2	111508	Knebel		2006823
3	345817	Schalter	F20CL, F220CL, 15FE-C, 20FE-C, 215FE-C, 220FE-C	6030003
4	111508	Knebel		2006823

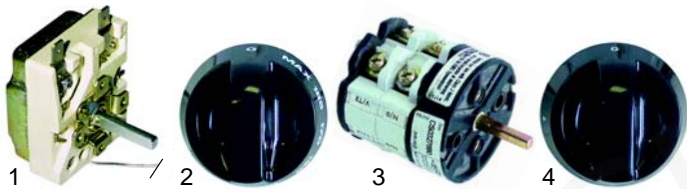

Abb.	Bestell-Nr.	Beschreibung	Gerätetyp	Ver.-Nr.
1	359272	Signallampe/grün		6061073
1	359273	Signallampe/gelb	Universal	6061072
2	345773	Mikroschalter		6043085

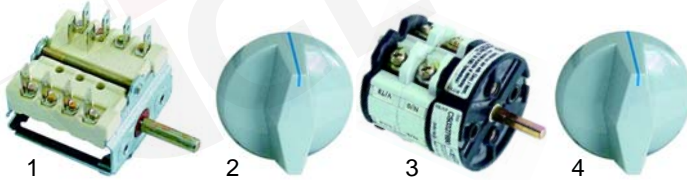

Abb.	B.-Nr.	Beschreibung	Gerätetyp	V.-Nr.
1	375375	Sicherheits-thermostat	F10L, F15L, F210L, F215L, 210FE, 922FE, F10CL, F15CL, F210CL, F215CL, 210FE-C,	6010036
1	375258	Sicherheits-thermostat	F20L, F220L, 15FE, 20FE, 215FE, 220FE, 920FE, 940FE, F20CL, F220CL, 15FE-C, 20FE-C, 215FE-C, 220FE-C	6010037
2	380244	Schütz	F10L, F15L, F210L, F215L, F10CL, F15CL, F210CL, F215CL	6046043
3	380204	Schütz	F20L, F220L, 15FE, 20FE, 210FE, 215FE, 220FE, 920FE, 922FE, 940FE, F20CL, F220CL, 15FE-C, 20FE-C, 210FE-C, 215FE-C, 220FE-C	6046038



Abb.	B.-Nr.	Beschreibung	Gerätetyp	Ver.-Nr.
1	379459	Temperaturregler	F10CL, F15CL, F20CL, F210CL, F215CL, F220CL, 15FE-C, 20FE-C,	6011142
2	693124	Frontfolie		2007069
3	379462	Fühler	210FE-C, 215FE-C, 220FE-C	6000106

Friteusen (Mechanik)

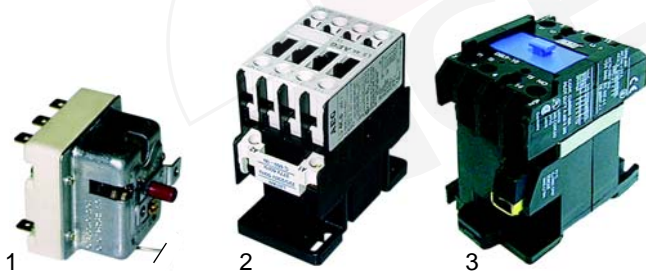

Abb.	B.-Nr.	Beschreibung	Gerätetyp	Ver.-Nr.
1	970354	Korb	FG07L/207L, FG07CL, F10L, F210L, F10CL, F210CL	2003001
2	970355	Korb	FG13L/213L, FG213CL,	2003002
3	970356	Korb	F15L, F215L, F15CL, F215CL	2003003



Abb.	Best.-Nr.	Beschreibung	Gerätetyp	V.-Nr.
1	970357	Korb	FG17L/217L,	2003008
2	970358	Korb	FG17CL/217CL, F20L, F220L, F20CL, F220CL	2003009
3	970359	Korb	207FG, 927FG, 210FE, 922FE, 210FE-C	2012898



Abb.	Best.-Nr.	Beschreibung	Gerätetyp	V.-Nr.
1	970360	Korb	13FG, 213FG, 213FG-C,	2012892
2	970361	Korb	15FE, 215FE, 15FE-C, 215FE-C	2012893



Abb.	Best.-Nr.	Beschreibung	Gerätetyp	V.-Nr.
1	970362	Korb	17FG, 217FG, 917FG,	2012895
2	970363	Korb	934FG, 17FG-C, 217FG-C, 20FE, 220FE, 920FE, 940FE, 20FE-C, 220FE-C	2012896

P010103901

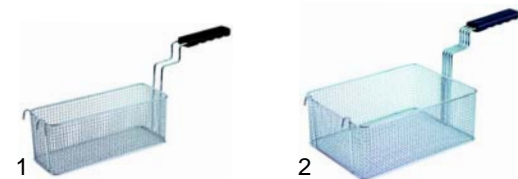