



Wasch- und Nachspülsysteme

Seite 250



Diverses und Luftfallen

Seite 254



Ablauf- und Filtersysteme

Seite 255



Tür- und Haubenmechanik

Seite 257

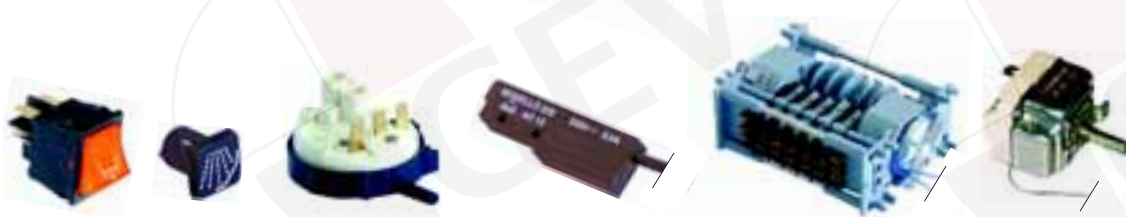

Elektrokomponenten

Seite 258



Dosiertechnik

Seite 261



Heizkörper und Boiler

Seite 262



Pumpen und Ersatzteile

Seite 263

Wasch- und Nachspülsysteme

Wascharm



Abb.	Best.-Nr.	Beschreibung	Geräte-Typ	Vergl.-Nr.
1	507142	Verlängerung	Jolly T, UNO T, UNO CLT, UNO CST	GLIT32
2	507147	Verlängerung	Jolly AT, UNO AT, UNO ACLT, UNO CST	GL2T32
3	507311	Dichtung		OR128
4	507139	Säule	Jolly T, Jolly AT, UNO T, UNO AT, DUE AT, UNO CLT, UNO CST, UNO ACLT, UNO ACST, DUE ACLT, DUE ACST	GLIT27
5	507150	Säule	Quattro T	GL4T27
6	507314	Dichtung		OR3131
7	507056	Mutter 1"		DP1



Abb.	Best.-Nr.	Beschreibung	Geräte-Typ	Vergl.-Nr.
1	507140	Wascharm/kpl.	Jolly T, Jolly AT, LINO T, UNO AT, UNO CLT, UNO CST, UNO ACST	GLIT28CM
2	507141	Wascharm		GLIT28P
3	507145	Wascharm/kpl.	DUE AT, DUE ACLT, DUE ACST	GL2T28CM
4	507146	Wascharm		GL2T28P



Abb.	Best.-Nr.	Beschreib.	Geräte-Typ	Vergl.-Nr.
1	507143	Wascharm/kpl.	DUE AT, DUE ACLT, DUE ACST	GL2AT28CMI
2	507141	Wascharm/kpl.	Quattro T	GL4T28I
3	507152	Wascharm/kpl.	Quattro T	GL4T29I

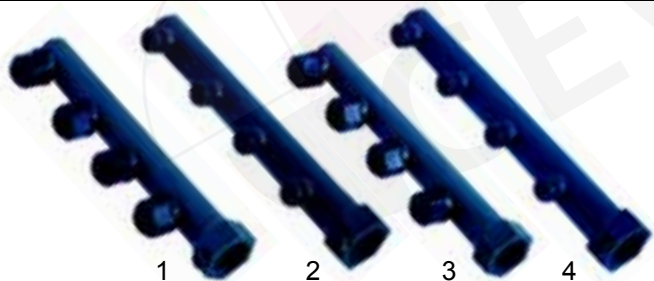

Abb.	Best.-Nr.	Beschreibung	Geräte-Typ	Vergl.-Nr.
1	507133	Düsenkappe		GL030
2	507134	Düseneinsatz		GL031
3	507311	Wascharmichtung		OR128
4	507135	Düsenhalter		GL032
5	507136	Gegenhalter	DUE AT, DUE ACLT, DUE ACST, Quattro T	GL033
6	507312	O-Ring		OR2050
7	507137	Endkappe		GL034A
8	507148	Überwurfmutter		GL34T27A

Nachspülarme



Abb.	Best.-Nr.	Beschreibung	Geräte-Typ	Vergl.-Nr.
1	507186	Nachspülarm/kpl.	Jolly T, UNO T, UNO CLT, UNO CST	GR119IN
2	507188	Nachspülarm/kpl.	Jolly AT, UNO AT, UNO ACST	GR1A19IN
3	507190	Nachspülarm/kpl.	DUE AT, DUE ACLT, DUE ACST	GR2A19IN



Abb.	Best.-Nr.	Beschreibung	Geräte-Typ	Vergl.-Nr.
1	507185	Nachspülarm/kpl.	Jolly T, UNO T, UNO CLT, UNO CST	GR119C
2	507187	Nachspülarm/kpl.	Jolly AT, UNO AT, UNO ACST	GR1A19C
3	507189	Nachspülarm/kpl.	DUE AT, DUE ACLT, DUE ACST	GR2A19C

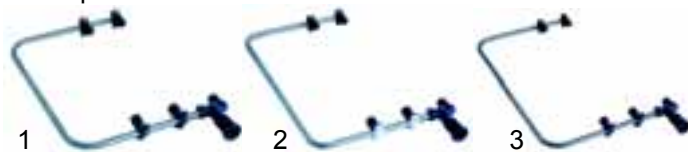

Abb.	Best.-Nr.	Beschreibung	Geräte-Typ	Vergl.-Nr.
1	507192	Nachspülarm/kpl.		GR419IN
2	507191	Nachspülrohr	Quattro T	GR419C



Abb.	B.-Nr.	Beschreibung	Geräte-Typ	Vergl.-Nr.
1	507179	Nachspülarmhalter	Jolly T, Jolly AT,	GR019ANT
2	507311	O-Ring	UNO T, UNO AT,	OR128
3	507177	Schlauchanschluss	UNO CLT, UNO CST,	GR016PNT
4	507309	O-Ring	UNO ACST, DUE AT,	OR122
5	507054	Mutter, 3/8"	DUE ACST, Quattro T	DO38A



Abb.	B.-Nr.	Beschreibung	Geräte-Typ	Vergl.-Nr.
1	507115	Drehstellenhalter	Jolly T, Jolly AT,	GGIT2
2	507309	O-Ring	UNO T, UNO AT,	OR122
3	507114	Scheibe	UNO CLT, UNO CST,	GG0T4
4	507116	Verlängerung	DUE ACST, DUE AT,	GGIT5
5	507054	Mutter 3/8"	ACLT	DO38A



Abb.	B.-Nr.	Beschreibung	Geräte-Typ	Vergl.-Nr.
1	507183	Düsenkappe	Jolly T, Jolly AT,	GR020
2	507184	Düseneinsatz	UNO T, UNO AT,	GR021
3	507180	Düsenhalter	UNO CLT, UNO CST,	GR019B
4	507181	Gegenstück	UNO ACST, DUE AT,	GR019D
5	507305	O-Ring	DUE ACLT,	OR106
6	507182	Endkappe	DUE ACST, Quattro T	GR019G

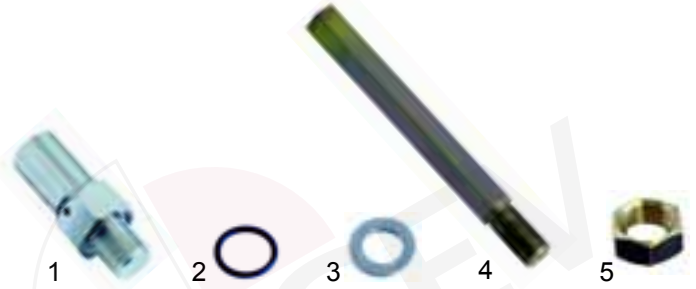

Abb.	B.-Nr.	Beschreibung	Geräte-Typ	Vergl.-Nr.
1	507322	Drehteller/kpl.	Quattro T	GG4T1
2	507126	Drehteller		GG3TA



Abb.	B.-Nr.	Beschreibung	Geräte-Typ	Vergl.-Nr.
1	507321	Drehteller/kpl.	Jolly T, Jolly AT, UNO T,	GGIT1
2	507117	Drehteller	UNO AT, UNO CLT,	GGITA
			UNO CST, UNO ACST,	
			DUE AT, DUE ACLT,	
			DUE ACLT	

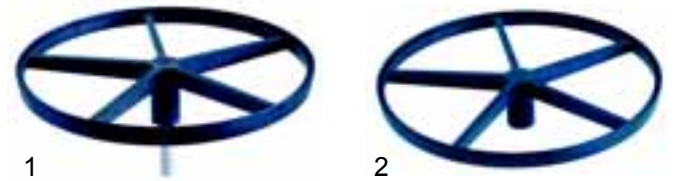

Abb.	B.-Nr.	Beschreibung	Geräte-Typ	Vergl.-Nr.
1	507127	CNS-Scheibe		GG3TB
2	507130	Seegering		GG3TE
3	507128	Kugellager	Quattro T	GG3TC
4	507129	Distanzbuchse		GG3TD
5	507132	Welle mit Kugel		GG4TFEG
6	507131	Überwurfschraube		GG3TH

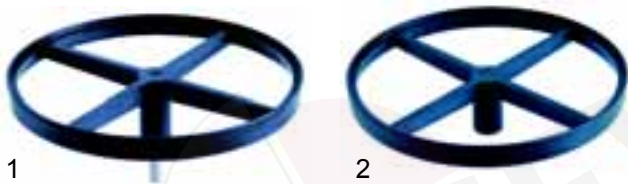

Abb.	B.-Nr.	Beschreibung	Geräte-Typ	Vergl.-Nr.
1	507118	CNS-Scheibe		GGITB
2	507121	Seegering	Jolly T, Jolly AT,	GGITE
3	507119	Kugellager	UNO T, UNO AT,	GGITC
4	507120	Distanzbuchse	UNO CLT, UNO CST,	GGITD
5	507122	Welle mit Kugel	UNO ACST, DUE AT,	GGITFEG
6	507123	Überwurfschraube	DUE ACLT, DUE ACLT	GGITH



Abb.	B.-Nr.	Beschreibung	Geräte-Typ	Vergl.-Nr.
1	507124	Drehstellenhalter	Quattro T	GG3T2
2	507309	O-Ring		OR122
3	507114	Scheibe		GG0T4
4	507125	Verlängerung		GG3T5
5	507054	Mutter 3/8"		DO38A

Quadratkorbsysteme (Nachspülarme)



Abb.	B.-Nr.	Beschreibung	Geräte-Typ	Vergl.-Nr.
1	507200	Nachspülarm/kpl.	Jolly Q, Jolly AQ, UNO Q, UNO AQ, UNO CSQ, UNO CLQ, UNO HCSQ	GRS1QCM
2	507199	Nachspülrohr		GRS1Q

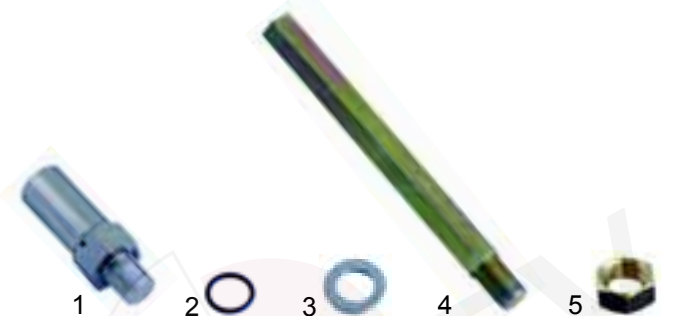

Abb.	B.-Nr.	Beschreibung	Geräte-Typ	Vergl.-Nr.
1	507202	Nachspülarm/kpl.	DUE ACSQ, DUE ACLQ	GRS2QCM
2	507201	Nachspülrohr		GRS2Q

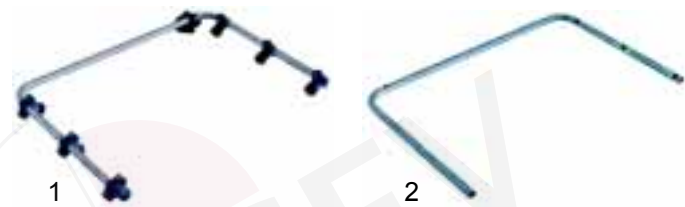

Abb.	B.-Nr.	Beschreibung	Geräte-Typ	Vergl.-Nr.
1	507195	Nachspülarmhalter	Jolly Q, Jolly AQ, UNO Q, UNO AQ, UNO CSQ, UNO CLQ, UNO HCSQ, DUE ACSQ, DUE ACLQ	GRS03
2	507196	Gegenstück		GRS04
3	507311	O-Ring		OR128
4	507198	Einschraubwinkel		GRS06
5	507197	Rohrhalter		GRS05

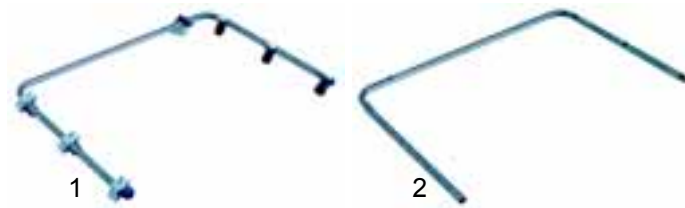

Abb.	B.-Nr.	Beschreibung	Geräte-Typ	Vergl.-Nr.
1	507183	Düsenkappe	Jolly Q, Jolly AQ, UNO Q, UNO AQ, UNO CSQ, UNO CLQ, UNO HCSQ, DUE ACSQ, DUE ACLQ	GR020
2	507184	Düsenersatz		GR021
3	507180	Düsenhalter		GR019B
4	507181	Gegenstück		GR019D
5	507305	O-Ring		OR106
6	507182	Endkappe		GR019G

Wasch- und Nachspülarme

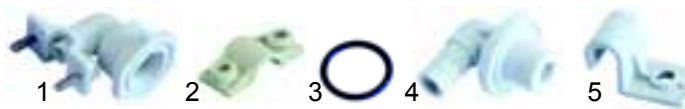

Abb.	B.-Nr.	Beschreibung	Geräte-Typ	V.-Nr.
1	507276	Wasch- u. Nachspülarm	UNO Q, UNO AQ	LSI16
2	507284	Wasch- u. Nachspülarm	Jolly Q, Jolly AQ, UNO CSR, UNO CLQ, UNO ACSQ	LSI16CSL



Abb.	B.-Nr.	Beschreibung	Geräte-Typ	V.-Nr.
1	507285	Wasch- u. Nachspülarm	DUE Q, DUE AQ	LSI26
2	507290	Wasch- u. Nachspülarm	DUE ACSQ, DUE ACLQ	LSI26CSL



Abb.	B.-Nr.	Beschreibung	Geräte-Typ	V.-Nr.
1	507291	Wasch- und Nachspülarm	Quattro Q, 61P	LSI46
2	507300	Wasch- und Nachspülarm	Quattro BA, Quattro SA 62P	LSISA6

Wascharm

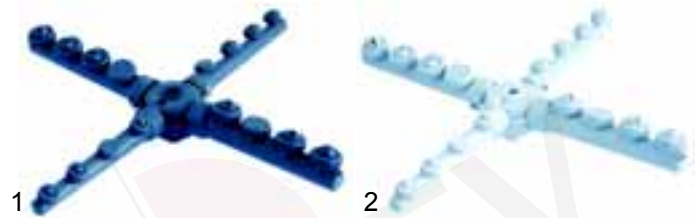

Abb.	B.-Nr.	Beschreibung	Geräte-Typ	V.-Nr.
1	507278	Wascharm rechts/kpl.	UNO Q, UNO AQ, Jolly Q, Jolly AQ, UNO CSQ, UNO CLQ, UNO ACSQ	LSI16BD
2	507279	Wascharm links/kpl.		LSI16BS
3	507287	Wascharm rechts/kpl.	DUE Q, DUE AQ, DUE ACLQ, DUE ACSQ	LSI26BD
4	507288	Wascharm links/kpl.		LSI26BS

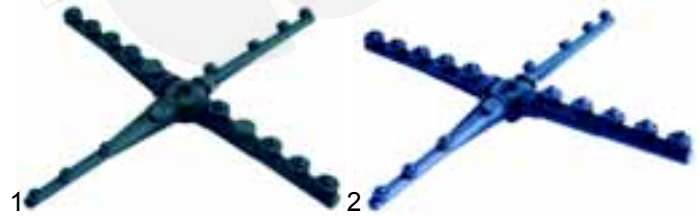

Abb.	B.-Nr.	Beschreibung	Geräte-Typ	V.-Nr.
1	507293	Wascharm rechts/kpl.	Quattro Q, 61P	LSI46BD
2	507294	Wascharm links/kpl.		LSI46BS
3	507302	Wascharm rechts/kpl.	Quattro BA, Quattro SA 62P	LSISA6BD
4	507303	Wascharm links/kpl.		LSISA6BS



Abb.	B.-Nr.	Beschreibung	Geräte-Typ	V.-Nr.
1	507277	Wascharm ohne Düsen (3)	Jolly __, UNO __	LSI16B
2	507286	Wascharm ohne Düsen (4)	DUE __	LSI26B
3	507292	Wascharm ohne Düsen (5)	Quattro __, G1P, 62P	LSI46B

Passend für IME/Omnishash

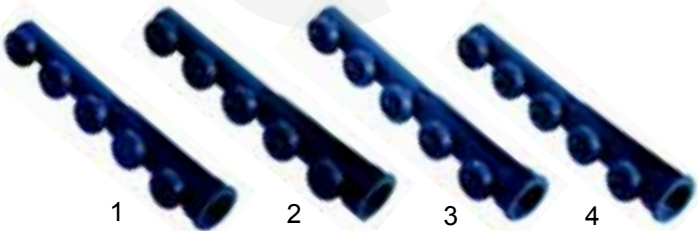

Abb.	B.-Nr.	Beschreibung	Geräte-Typ	V.-Nr.
1	507265	Waschdüse rechts (klein)	UNO __, Jolly __,	LSI015
2	507266	Waschdüse links (klein)	DUE __, Quattro Q	LSI016
3	507298	Waschdüse rechts (groß)	Quattro BA, Quat-	LSISA15
4	507299	Waschdüse links (groß)	tro SA, 61P, 62P	LSISA16
5	507267	Waschdüsenverschraubung		LSI017
6	507268	Blinddüse		LSI018



Abb.	B.-Nr.	Beschreibung	Geräte-Typ	V.-Nr.
1	507282	Nachspülarm/kpl. (3)	Jolly Q, UNO Q	LSI16CDS
2	507281	Nachspülarm rechts/kpl. (4)		LSI26CD
3	507283	Nachspülarm links (4)	DUE __ Q	LSI26CS
4	507296	Nachspülarm rechts/kpl. (klein)	Quattro Q, Quattro BA,	LSI46CD
5	507297	Nachspülarm links/kpl. (klein)	Quattro SA, 61P, 62P	LSI46CS

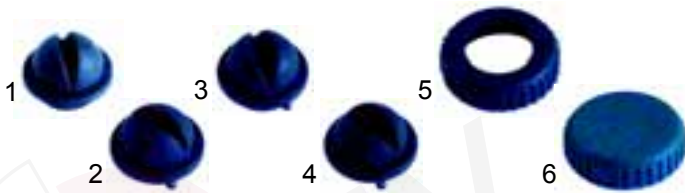

Abb.	B.-Nr.	Beschreibung	Geräte-Typ	V.-Nr.
1	507280	Nachspülarm ohne Düsen		LSI16C
2	507289	Nachspülarm ohne Düsen		LSI26C
3	507295	Nachspülarm ohne Düsen		LSI46C
4	507269	Düse		LSI020
5	507270	Düsenverschraubung		LSI021
6	507271	Blinddüse		LSI022



Abb.	B.-Nr.	Beschreibung	Geräte-Typ	V.-Nr.
1	507272	Wascharmkreuz		LSI0607AN LSI0607A
2	507310	Wascharmdichtung		OR124
3	507313	O-Ring/Nachspülarm		OR3056
4	507275	Lagerbuchse		LSI07
5	507261	Rändlschraube		LS09P
6	507224	Scheibe		LI034P



Abb.	B.-Nr.	Beschreibung	Geräte-Typ	V.-Nr.
1	507229	Nachspülstift unten	Jolly Q, Jolly AQ,	LI18F
2	507228	Verlängerung	UNO Q, UNO AQ,	LI130
3	507222	Wascharmhalter unten	UNO CSQ, UNO CLQ, UNO ALSQ, DUE AQ,	LI029CB LI135D
4	507307	O-Ring	DUE ACSQ,	OR117
5	507051	Mutter, 1/4"	DUE ACLQ	DO14



Abb.	B.-Nr.	Beschreibung	Geräte-Typ	V.-Nr.
1	507260	Nachspülstift		LS08
2	507232	Verlängerung		LI330
3	507221	Wascharmhalter unten	Quattro Q	LI029CA
4	507239	Nachspülanschluss		LI533F
5	507238	Nachspülanschluss	Quattro BA	LI433F
5	507252	Nachspülanschluss	Quattro SA	LISA33F
6	507309	O-Ring		OR122
7	507053	Mutter, 3/4"		DO38



Abb.	Bestell-Nr.	Beschreibung	Geräte-Typ	Vergl.-Nr.
1	507227	Waschrohr, 160mm	Jolly, UNO	LI12830
2	507231	Waschrohr, 195mm	DUE	LI22830
3	507225	Halter		LI126FC
4	507314	O-Ring	Jolly, UNO,	OR3131
5	507056	Mutter	DUE	DP1



Abb.	Bestell-Nr.	Beschreibung	Geräte-Typ	Vergl.-Nr.
1	507235	Waschrohr 275	Quattro	LI428
2	507237	Halter	Quattro Q	LI430FC
3	507218	Halter		LI027
4	507250	Verlängerung	Quattro SA, Quattro B	LISA26A LISA26F
5	507251	Befestigung		LISA26F
6	507316	O-Ring		OR3181
7	507058	Mutter, 1 1/4"		DP114, DP14



Abb.	Bestell-Nr.	Beschreibung	Geräte-Typ	Vergl.-Nr.
1	507254	Wascharmhalter	UNO, Jolly, DUE	LS01
2	507263	Wascharmhalter	Quattro Q	LS5
3	507264	Wascharmhalter	61P, 62P	LS6012



Abb.	Bestell-Nr.	Beschreibung	Geräte-Typ	Vergl.-Nr.
1	507050	Blindeckel		CERI50NT
2	507318	O-Ring		OR6275
3	524178	Mutter		CERI45
4	530000	Enthärter		CERI47



Abb.	Bestell-Nr.	Beschreibung	Geräte-Typ	Vergl.-Nr.
1	507255	Dichtung		LS02
2	507258	Tellerscheibe		LS03P
3	507260	Nachspüsstift		LS08

Diverses



Abb.	Bestell-Nr.	Beschreibung	Geräte-Typ	Vergl.-Nr.
1	507104	Verteiler, 3 Wege		GB017
2	507105	Verteiler, 4 Wege		GB055
3	507193	Y-Stück		GR6183



Abb.	Bestell-Nr.	Beschreibung	Geräte-Typ	Vergl.-Nr.
1	507198	Winkelanschluss	__CS, __CL	GRS06
2	507194	Winkelanschluss	61P, 62P	GR6193
3	507256	Dichtung	61P, 62P	LS026

Salzbehälter und Enthärter



Abb.	Bestell-Nr.	Beschreibung	Geräte-Typ	Vergl.-Nr.
1	510929	Salzbehälter kpl.		CERI43
2	524177	Deckel		CERI46
3	510898	O-Ring		CERI46A
4	524178	Mutter		CERI45
5	507045	Dichtung		CERI44

Klarspülmittelzubehör



Abb.	Bestell-Nr.	Beschreibung	Geräte-Typ	Ver.-Nr.
1	507021	Deckel (Dosiergerät)		AMOTCBPL
2	507019	Stift		AMO29

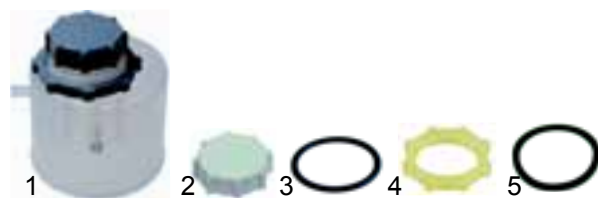

Abb.	Bestell-Nr.	Beschreibung	Geräte-Typ	Ver.-Nr.
1	507016	Klarspülmittelbehälter		AM027
2	507018	Rahmen/schwarz		AM028N
3	507017	Rahmen/blau		AM028A
4	507020	Deckel		AM030
5	507019	Stift		AM029

Reinigerzubehör



Abb.	Bestell-Nr.	Beschreibung	Geräte-Typ	Vergl.-Nr.
1	507061	Einschraubwinkel		DSDET040
2	507075	Dichtung		G15101G
3	507330	Mutter, M10 x 1		VD10IP1
4	507062	Endkappe		DSDET043
5	507063	Einschraubwinkel		DSDET62P
6	507113	Dichtung		GDSDET62P
7	507331	Mutter, M10		VDDDET62P

Luftfallen



Abb.	Bestell-Nr.	Beschreibung	Geräte-Typ	Vergl.-Nr.
1	507171	Luftfalle		GP025
2	507080	Dichtung		G382615G
3	507052	Mutter, 3/4"		DO34
4	507078	Dichtung		G25152G
5	507172	Winkelanschluss		GP026A
6	507173	Überwurfmutter		GP026B

Ablauf- und Filtersysteme



Abb.	Best.-Nr.	Beschreibung	Geräte-Typ	Vergl.-Nr.
1	507089	Ausgang, Filter unten	Jolly, UNO, DUE	GA115RAB
2	507088	Ausgang, Filter oben		GA115R
3	507100	Ausgang (CNS)	UNO, DUE	GAPS335



Abb.	Best.-Nr.	Beschreibung	Geräte-Typ	Vergl.-Nr.
1	507094	Ausgang, Filter unten		GA315RA
2	507093	Ausgang, Filter oben		GA315R

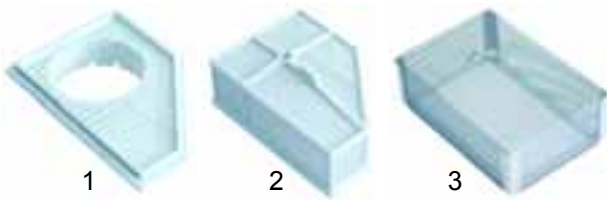

Abb.	Bestell-Nr.	Beschreibung	Geräte-Typ	Ver.-Nr.
1	507083	Filterbefestigungsstift	Jolly, UNO, DUE	GA012B
2	507096	Filterbefestigungsstift	Quattro P	GA512 GA5120T
3	507082	Stift/Ablaufpumpe	Quattro Q	GA012A
4	507098	Filterbefestigungsstift	61P, 62P	GA6122
5	507084	Filterbefestigungsstift	Quattro SA	GA012C
6	507085	Mutter		GA013



Abb.	Bestell-Nr.	Beschreibung	Geräte-Typ	Ver.-Nr.
1	507086	Ansaugventil		GA111
2	507315	O-Ring	Jolly, UNO, DUE	OR3168
3	507058	Mutter 1 1/4"		DP114



Abb.	B.-Nr.	Beschreibung	Geräte-Typ	V.-Nr.
1	507087	Ansaugventil (Laugenpumpe)		GA111T
2	507315	O-Ring	Quattro Q, Laugenpumpe	OR3168
3	507058	Mutter, 1 1/4"		DP114



Abb.	B.-Nr.	Beschreibung	Geräte-Typ	V.-Nr.
1	507092	Ansaugventil		GA311
2	507316	O-Ring	Quattro, 61P, 62P	OR3181
3	507057	Mutter, 1 1/2"		DP112

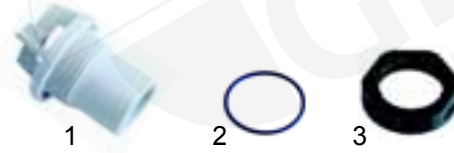

Abb.	Bestell-Nr.	Beschreibung	Geräte-Typ	Vergl.-Nr.
1	507243	Flachfilter	UNO	LIF12V1P
2	507244	Flachfilter	DUE	LIF22V1P

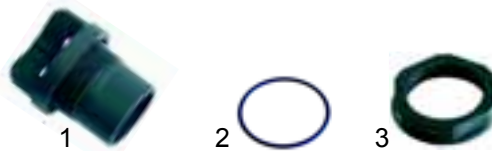

Abb.	Bestell-Nr.	Beschreibung	Geräte-Typ	Vergl.-Nr.
1	507246	Flachfilter		LIF4V4P
2	507248	Flachfilter	Quattro	LIF4V4TPP
3	507245	Flachfilter (CNS)	61P, 62P	LIF4V4

Überlaufrohre



Abb.	Bestell-Nr.	Beschreibung	Geräte-Typ	Vergl.-Nr.
1	507203	Überlaufrohr		GS116CC
2	507204	Ablaufventil	Jolly, UNO, DUE	GS117
3	507314	O-Richtung		OR3131
4	507056	Mutter		DP1



Abb.	Bestell-Nr.	Beschreibung	Geräte-Typ	Vergl.-Nr.
1	507212	Überlaufrohr, 165	Quattro Q, Quattro BA	GS416CC
2	507217	Überlaufrohr, 205	Quattro SA	GSSA16
3	507214	Überlaufrohr, 190	61P, 62P	GS6013



Abb.	Best.-Nr.	Beschreibung	Geräte-Typ	Ver.-Nr.
1	507090	Ansaugschlauch	Jolly, UNO, DUE	GA18
2	507138	Druckschlauch	Jolly, UNO T, UNO__T	GLIT22
3	507144	Druckschlauch	DUE T, DUE__T	GL2T22



Abb.	Bestell-Nr.	Beschreibung	Geräte-Typ	Vergl.-Nr.
1	507209	Ablaufventil		GS317
2	507315	O-Ring	Quattro, 61P, 62P	OR3168
3	507058	Mutter		DP114



Abb.	Best.-Nr.	Beschreibung	Geräte-Typ	Ver.-Nr.
1	507097	Ansaugschlauch	Quattro	GA538
2	507149	Druckschlauch	Quattro T	GL4T22

Ansaug- und Druckschläuche

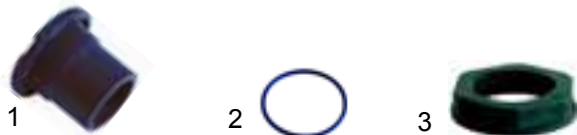

Abb.	Bestell-Nr.	Beschreibung	Geräte-Typ	Ver.-Nr.
1	507206	Ablaufwinkel	Jolly, UNO, DUE	GS121
2	507205	Formschlauch (2)	Jolly, UNO	GS120
3	507208	Formschlauch (2)	DUE	GS220



Abb.	Best.-Nr.	Beschreib.	Geräte-Typ	V.-Nr.
1	507095	Ansaugschlauch unten	Quattro BA, Quattro SA, 61P, 62P	GA38
2	507103	Ansaugschlauch oben	Quattro BA, Quattro SA, 62P	GASA8



Abb.	Bestell-Nr.	Beschreibung	Geräte-Typ	Ver.-Nr.
1	507210	Ablaufwinkel		GS321
2	507059	Mutter	Quattro Q	DP14
3	507213	Formschlauch		GS520



Abb.	B.-Nr.	Beschreibung	Geräte-Typ	V.-Nr.
1	507149	Druckschlauch unten (Pumpe)		GL4T22
2	507253	Druckschlauch oben (Pumpe)	Quattro BA, Quattro SA	LISA392
3	507304	Druckschlauch oben (Halter)		LSSA13A

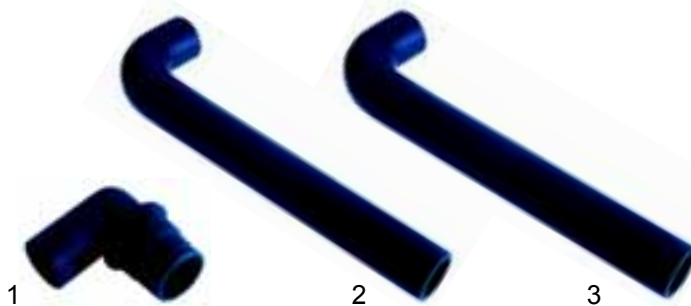

Abb.	Best.-Nr.	Beschreibung	Geräte-Typ	Ver.-Nr.
1	507207	Ablaufschlauch (22)	Jolly, UNO, DUE	GS130
2	507211	Ablaufschlauch (38)	Quattro, 61P, 62P	GS330



Abb.	Best.-Nr.	Beschreibung	Geräte-Typ	Ver.-Nr.
1	507328	Ansaugschlauch		GSMAPS
2	507216	Ansaugschlauch		GSMPS5
3	507329	Druckschlauch		CEPS032



Abb.	Best.-Nr.	Beschreibung	Geräte-Typ	Ver.-Nr.
1	507325	Druckschlauch	UNO Q, UNO_Q	GLMSIC1
2	507326	Druckschlauch	DUE Q, DUE_Q	GLMSIC2A



Abb.	Best.-Nr.	Beschreibung	Geräte-Typ	Ver.-Nr.
1	507327	Druckschlauch	Quattro Q	GLMSIC4
2	507153	Druckschlauch	61P	GLMSI61P

Tür- und Haubenmechanik



Abb.	B.-Nr.	Beschreibung	Geräte-Typ	Ver.-Nr.
1	507029	Türfeder rechts (2mm)	Jolly	AMMP1DX
2	507030	Türfeder links (2mm)		AMMP1SX
3	507027	Türfeder rechts (2,3mm)	Jolly A	AMMP1A2DX
4	507028	Türfeder links (2,3mm)		AMMP1A2SX
5	507013	Buchse	Jolly,	AMO12M
6	507023	Türwelle	Jolly A	AM112NTM
7	507031	Platte		AMOPFPPM



Abb.	B.-Nr.	Beschreib.	Geräte-Typ	Ver.-Nr.
1	507012	Buchse	UNO, DUE,	AMO12
2	507015	Seegering	Quattro	AMO13NT
3	507022	Türwelle 90	UNO	AM112NT
4	507024	Türwelle 120	DUE	AM212NT
5	507026	Türwelle 175	Quattro O/+	AM512
6	507025	Türwelle 170	Quattro BA/SA	AM412, AM412NTM

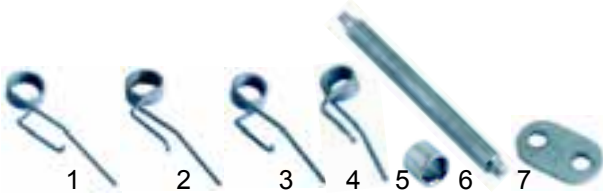

Pos.	Bestell-Nr.	Beschreibung	Geräte-Typ	Ver.-Nr.
1	507011	Türschnapper kpl.	Universal	AM011

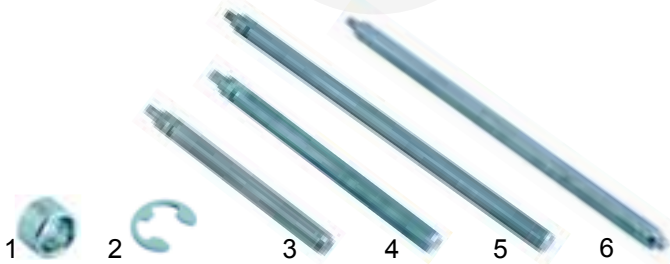

Abb.	Best.-Nr.	Beschreibung	Geräte-Typ	Ver.-Nr.
1	507053	Mutter 3/8"		DO38A
2	345529	Mikroschalter	Jolly, UNO CS, DUE CS	CEMP12CS
3	507036	Mikroschalterhalter		CEMP13CS
4	345528	Mikroschalter	UNO, DUE, Quattro	CEMP12
5	507034	Mikroschalterhalter		CEMP13



Abb.	Best.-Nr.	Beschreibung	Geräte-Typ	Ver.-Nr.
1	345515	Mikroschalter	UNO CL, DUE CL	CEMP12CL
2	507035	Mikroschalterhalter		CEMP13CL
3	507309	O-Ring		OR122
4	507037	Befestigungswinkel		CEMP18
5	507312	O-Ring		OR2050
6	507038	Feder	Universal	CEMP20
7	507039	Welle		CEMP21
8	507040	Seegering		CEMP22
9	507041	Türschaltervorderteil		CEMP23



Abb.	Bestell-Nr.	Beschreibung	Geräte-Typ	Ver.-Nr.
1	507009	Griff (Kunststoff)		AMO10PC
2	507008	Griff (Kunststoff)		AMO10PA
3	507005	Griff (CNS) rund, 250mm		AMO10F
4	507010	Griff (CNS) eckig, 250mm		AMO10R



Abb.	Bestell-Nr.	Beschreibung	Geräte-Typ	Vergl.-Nr.
1	507159	Haubengriff	61P, 62P	GMMN6151
2	507157	Feder		GMMML6261

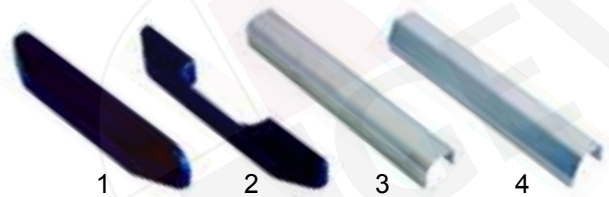

Abb.	Bestell-Nr.	Beschreibung	Geräte-Typ	Vergl.-Nr.
1	507156	Federhalter	61P, 62P	GMMML6251
2	507158	Federspanner		GMMML6271



Abb.	Bestell-Nr.	Beschreibung	Geräte-Typ	Vergl.-Nr.
1	507167	Buchse		GMMN6191
2	507166	Welle		GMMN6181
3	507165	Halter unten	62P ab 1997	GMMN6171S
4	507162	Halter oben		GMMN6161S
5	507170	Hebeblock		GMMN6301S



Abb.	Bestell-Nr.	Beschreibung	Geräte-Typ	Vergl.-Nr.
1	507167	Buchse		GMMN6191
2	507166	Welle		GMMN6181
3	507163	Halter unten	61P, 62P ab 1996	GMMN6171
4	507160	Halter oben		GMMN6161
5	507169	Hebeblock		GMMN6301

Elektrokomponenten

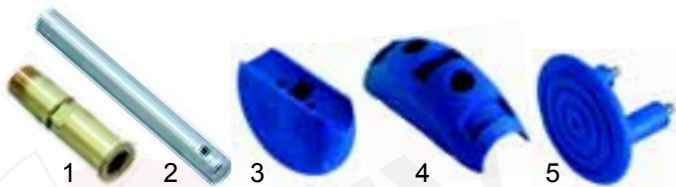
Schalter



Abb.	Best.-Nr.	Beschreibung	Geräte-Typ	Ver.-Nr.
1	301139	Hauptschalter	Jolly, UNO CS,	CEIN3012
2	301131	Taster/Nachspülung	UNO CL, DUE CS,	CEPUR3012
3	301130	Taster	DUE CL	CEPUC3012



Abb.	B.-Nr.	Beschreibung	Geräte-Typ	Ver.-Nr.
1	359124	Fassung/gelb		CESPE32
2	359123	Fassung/grün	Jolly, UNO CS,	CESPE31
3	359130	Signalelement, 230V	UNO CL, DUE	CESP27
3	359132	Signalelement/grün, 230V	CS, DUE CL	CESP27V



Abb.	Best.-Nr.	Beschreibung	Geräte-Typ	Ver.-Nr.
1	301017	Hauptschalter/grün	UNO, UNO A,	CEDV01VSL
2	301018	Taster/Start	DUE, DUE A,	CEPUASL
3	301132	Taster/Nachspülung	Quattro 1-polig	CEPUVSL



Abb.	Best.-Nr.	Beschreibung	Geräte-Typ	Ver.-Nr.
1	301138	Signallampe/doppelt	UNO, UNO A,	CESDAV
2	301133	Taster/Regenerierung	DUE, DUEA,	CEPURIG
3	301134	Taster/Ablaufpumpe	Quattro	CEPUPS



Abb.	Best.-Nr.	Beschreibung	Geräte-Typ	Ver.-Nr.
1	301136	Taster/Start	Quattro 3-polig	CEPUC2
2	301140	Umschalter		CEDVC2



Abb.	Best.-Nr.	Beschreibung	Geräte-Typ	Ver.-Nr.
1	301137	Umschalter, 24V		CEDV6364
2	301135	Taster, 24V	62P bis 1998	CEPU6374
3	359787	Blindkappe		CESB6384



Abb.	B.-Nr.	Beschreibung	G.-Typ	Ver.-Nr.
1	345562	Kontaktblock, 1 Öffner		CECNC6294
1	345525	Kontaktblock, 1 Schließer		CECNO6244
2	345482	Halter	62P bis 1998	CEIN623B4
3	345526	Stellungswähler, 2Stellungen		CEIN623A4
3	345527	Stellungswähler, 3 Stellungen		CESC6284



Abb.	B.-Nr.	Beschreibung	Geräte-Typ	Ver.-Nr.
1	359358	Fassung/gelb	62P bis 1998	CESP6274
2	359359	Fassung/grün		CESP6224
3	359129	Signalelement, 24V		CESP6394

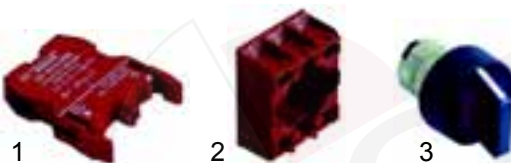

Abb.	Best.-Nr.	Beschreibung	Geräte-Typ	Ver.-Nr.
1	359777	Symbol O		CESB6184
2	359780	Symbol I		CESB6264
3	359786	Symbol/Waschen	62P bis 1998	CESB6354
4	359785	Symbol/Nachspülung		CESB6344
5	359784	Symbol/Blindkappe		CESB6334

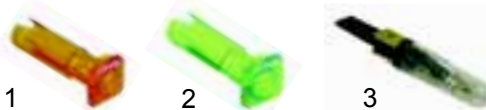

Abb.	B.-Nr.	Beschreibung	Geräte-Typ	Ver.-Nr.
1	359781	Symbol/Programm, kurz	62P bis 1998	CESB6304
2	359783	Symbol/Programm mittel		CESB6324
3	359782	Symbol/Programm lang		CESB6314
4	359779	Symbol/Temp. Tank		CESB6204
5	359778	Symbol/Boiler		CESB6194



Abb.	Bestell-Nr.	Beschreibung	Geräte-Typ	Ver.-Nr.
1	345651	Umschalter, 2-polig	61P, 62P	CEDP62PS
2	345524	Taster, 0/1		CETSTR01
3	345523	Taster/Programm		CETSTGCL



Abb.	B.-Nr.	Beschreibung	Geräte-Typ	Ver.-Nr.
1	359124	Fassung/gelb	61P, 62P	CESPE32
2	359123	Fassung/grün		CESPE31
3	359130	Signalelement, 230V		CESP27
3	359132	Signalelement/grün, 230V		CESP27V

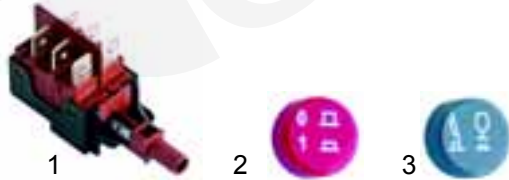

Abb.	Bestell-Nr.	Beschreibung	Geräte-Typ	Ver.-Nr.
1	359773	Symbol, 0-1	61P, 62P	CEGA2328
2	359775	Symbol, Boiler		CEGV2320
3	359774	Symbol, Tank		CEGV2307
4	359776	Symbol, Zyklus		CEGV2329



Abb.	Bestell-Nr.	Beschreibung	Geräte-Typ	Vergl.-Nr.
1	345529	Mikroschalter	Jolly, UNO, DUE, Quattro	CEMP12CS
2	345528	Mikroschalter	UNO, DUE, Quattro bis 1999	CEMP12
3	345560	Mikroschalter	61P, 62P	CEMP62PS
4	345561	Mikroschalter		CEMP62PS3



Abb.	Bestell-Nr.	Beschreibung	Geräte-Typ	Vergl.-Nr.
1	345116	Magnetschalter	62P	CERD6434
2	345336	Magnet		CERM6444

Timer



Abb.	Bestell-Nr.	Beschreibung	Geräte-Typ	Vergl.-Nr.
1	360220	150 sec	Jolly	CETF150J
2	360219	120 sec	UNO, DUE	CETF12
3	360221	Regenerierung		CETF20



Abb.	Bestell-Nr.	Beschreibung	Geräte-Typ	Vergl.-Nr.
1	360222	240 sec.	Quattro 1-polig	CETF24B
2	360218	120/180/240 sec.	Quattro 3-polig	CETD1224B



Abb.	Best.-Nr.	Beschreibung	Geräte-Typ	Ver.-Nr.
1	360228	180 sec./Ablaufpumpe	Quattro Q	CEPSTFB
2	360225	20 min./Regenerierung		CETR20B

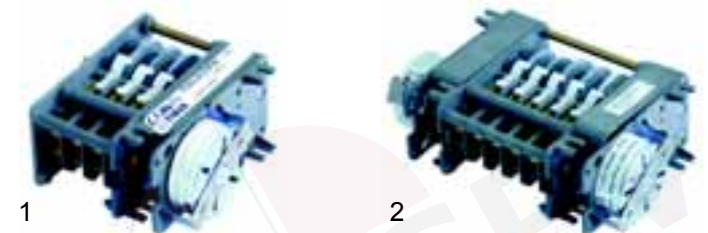

Abb.	Best.-Nr.	Beschreibung	Geräte-Typ	Ver.-Nr.
1	360215	90/180 sec.	61P	CET2C61P
2	360217	60/120/180 sec., 24V	62P	CET3C6



Abb.	Best.-Nr.	Beschreibung	Geräte-Typ	Ver.-Nr.
1	360216	60/120 sec., 230V	62P	CET2C6S
2	507043	Knebel		CEMTR

Pressostate

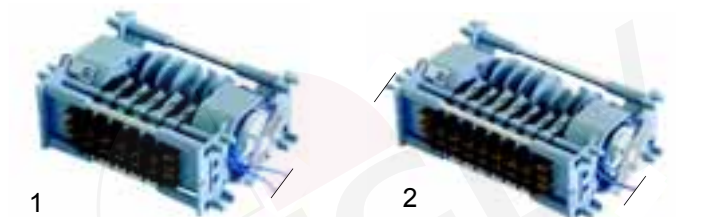

Abb.	Best.-Nr.	Beschreibung	Geräte-Typ	Ver.-Nr.
1	541164	50/20	Jolly, UNO, DUE, Quattro Q, 61P, 62P	CEPR
2	541165	60/30	Quattro BA, Quattro SA	CEPRE
3	507174	Verbinder		GPRTP

Schütze/Relais



Abb.	B.-Nr.	Beschreibung	Geräte-Typ	Ver.-Nr.
1	380420	Relais	Jolly	CER16A2NO
2	380415	Schütz, 3S, 1Ö	UNO, DUE, Quattro Q, 61P, 62P	CECTF
3	380212	Schütz, 4S	Quattro BA/Quattro SA	CECT



Abb.	Best.-Nr.	Beschreibung	Geräte-Typ	Ver.-Nr.
1	380411	Schütz, 3S, 1Ö	62P bis 1997	CECT24P
2	380209	Schütz, 4S		CECT24G

Magnetventile



Abb.	Best.-Nr.	Beschreibung	Geräte-Typ	V.-Nr.
1	370017	1-fach, 230V AC	61P, 62P	CEEV1
1	370029	1-fach, 24V AC	62P bis 1996	CEEV124
2	370021	2-fach, 230V AC	Jolly, UNO, DUE, Quattro	CEEV2
3	370240	3-fach, 230V AC, mit Reduzierung für Enthärter		CEEV3

Thermostate



Abb.	Bestell.-Nr.	Beschreibung	Geräte-Typ	Vergl.-Nr.
1	390186	Tank, 55°C, fest	Universal	CETV55
2	390006	0 - 95°C		CETB85
3	110100	Knebel, 0 - 90°C		CEMTB



Pos.	Bestell.-Nr.	Beschreibung	Geräte-Typ	Ver.-Nr.
1	390455	Sicherheitsthermostat/Boiler, 110°C	Universal	CESB454
2	390456	Sicherheitsthermostat/Tank, 85°C		CESV001

Thermometer

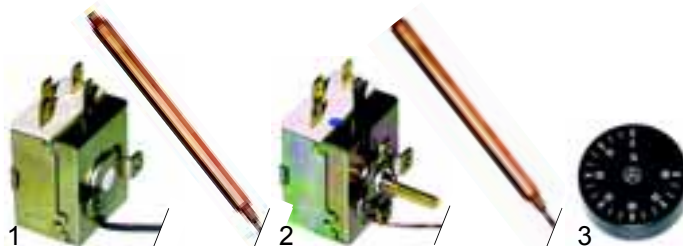

Pos.	Bestell.-Nr.	Beschreibung	Geräte-Typ	Ver.-Nr.
1	541095	0 - 120°C	Quattro BA/SA, 62P bis 1996	CETEM

Klemmleisten



Abb.	Bestell.-Nr.	Beschreibung	Geräte-Typ	Vergl.-Nr.
1	550278	3-polig		CEMOS
2	550411	6-polig		CEMOS3F



Abb.	Best.-Nr.	Beschreibung	Geräte-Typ	Ver.-Nr.
1	358512	Sicherungsschalter		CEMFSTR
2	358074	Sicherung, 5 x 20, flink, 5A, VPE 10 Stck.		CEFU5205A

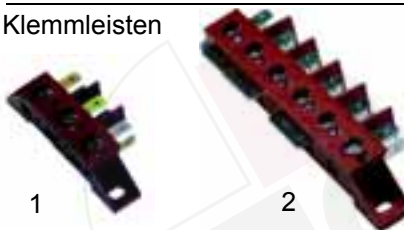

Abb.	Best.-Nr.	Beschreibung	Geräte-Typ	V.-Nr.
1	400134	Transformator, 100/220VA, Primär 230/400V ± 15V, Sekundär 12 - 0 - 12V	62P	CETRS24
2	365046	Entstörfilter		CEFA

Zeitrelais



Abb.	Bestell-Nr.	Beschreibung	Geräte-Typ	Vergl.-Nr.
1	360230	Socket, 8-polig		CETF60A
2	360223	Anzugsverzögernd, 6 sec. fest, 24V AC		CETF60
2	360224	Anzugsverzögernd, 6 sec. fest, 230V AC		CETF6045A

Dosiertechnik



Abb.	Bestell-Nr.	Beschreibung	Geräte-Typ	Vergl.-Nr.
1	361018	Dosiergerät		DSBM3NT
2	361054	Dosiergerät		DSAM3 DSAM3NT



Abb.	Bestell-Nr.	Beschreibung	Geräte-Typ	Vergl.-Nr.
1	361337	Schlauchanschluss		DSVNR17NT
2	361338	Dichtung		G16221F
3	361339	Scheibe		DSVNR16
4	361340	Feder		DSVNR14
5	361341	CNS-Kugel		DSVNR13
6	361342	Körper		DSVNR12
7	361348	Rückschlagventil		DS8S



Abb.	Bestell-Nr.	Beschreibung	Geräte-Typ	Vergl.-Nr.
8	361343	O-Ring		OR103
9	361344	Feder		DS4
10	361345	O-Ring		OR422
11	361308	Membrane		DS06M3
12	361346	Ventilkörper		DS9
13	361347	Schlauchanschluss		DS10NT

Heizkörper Tankheizkörper

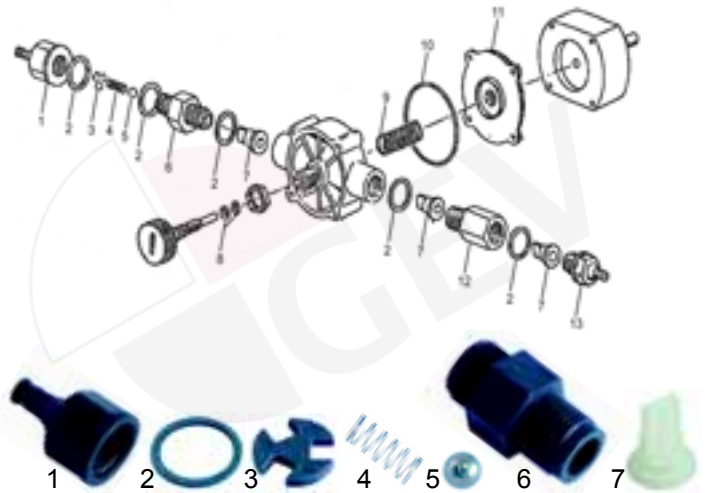

Abb.	B.-Nr.	Leistung	Heizkreise/ Spannung	Geräte-Typ	Ver.-Nr.
1	416219	800W	1/230V	Jolly	CERV8
1	416216	1800W	1/230V	UNO, DUE	CERV18
2	416217	2500W	1/230V	Quattro Q	CERV25
3	416218	4500W	3/230V	Quattro BA/SA, 61P, 62P	CERV453F



Abb.	Bestell-Nr.	Beschreibung	Geräte-Typ	Vergl.-Nr.
1	507332	Dichtung, 1/4"		G18122GT
2	361182	Mutter, 1/4"		VDRV
3	507333	Dichtung, 1 1/4"		G50403GT
4	507334	Mutter, 1 1/4"		DO114

Boilerheizkörper

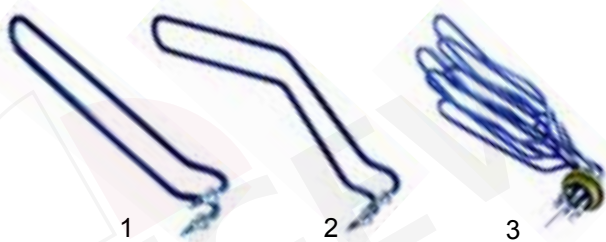

Abb.	B.-Nr.	Leistung/ Beschrg.	Heizkreise/ Spannung	Geräte-Typ	Ver.-Nr.
1	416210	2200W	1/230V	Jolly	CERB22
2	416211	2700W	1/230V	UNO, DUE	CERB2712
3	416212	3000W	1/230V	Quattro	CERB30
4	507335	Dichtung			G42303S



Abb.	B.-Nr.	Leistung/ Beschrg.	Heizkreise/ Spannung	Geräte-Typ	Ver.-Nr.
1	416213	4500W	3/230V		CERB453F
2	416214	6000W	3/230V	Quattro BA/SA,	CERB603F
3	416215	9000W	3/230V	61P, 62P	CERB903F
4	510409	Dichtung			ORR33F

Boiler



Abb.	Bestell-Nr.	Beschreibung	Geräte-Typ	Vergl.-Nr.
1	507106	Zulauf/hinten	UNO	GB11
2	507108	Zulauf/hinten	DUE	GB21
3	507107	Zulauf/unten	Jolly	GB11NT



Pos.	Best.-Nr.	Beschreibung	Geräte-Typ	V.-Nr.
1	507109	Für dreiphasigen Heizkörper	Quattro BA/SA, 61P/62P	GB4133F



Abb.	Best.-Nr.	Beschreibung	Geräte-Typ	V.-Nr.
1	507111	Für einphasigen Heizkörper	Quattro Q	GB4821F
2	507112	Für dreiphasigen Heizkörper		GB4823F

Pumpen

Laugenpumpen



Abb.	Best.-Nr.	Beschreibung	Geräte-Typ	V.-Nr.
1	500346	34W/230V	UNO, DUE	CEPS031
2	500347	34W/230V	Quattro Q	CEPS031482



Abb.	Bestell-Nr.	Beschreibung	Geräte-Typ	Vergl.-Nr.
1	500337	1PS/230V	Quattro, 61P, 62P	EP100
2	500338	1PS/230V	Quattro BA/SA, 62P	EP100C

Waschpumpen



Abb.	Bestell-Nr.	Beschreibung	Geräte-Typ	Vergl.-Nr.
1	500340	0,3PS/230V	Jolly, UNO	EP30
2	500343	0,6PS/230V	DUE	EP60

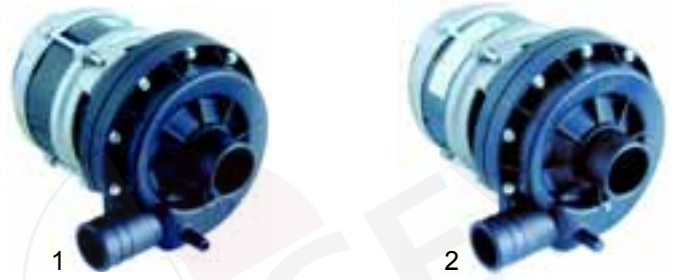

Pumpe		1 Laufrad		2 Gleitringdichtung		3 Gehäusedichtung		4 Pumpendeckel		5 Kondensator	
B.-Nr.	V.-Nr.	B.-Nr.	V.-Nr.	B.-Nr.	V.-Nr.	B.-Nr.	V.-Nr.	B.-Nr.	V.-Nr.	B.-Nr.	V.-Nr.
500340	EP30	507067	EP253	510693	EP04	507066	EP252NT	507065	EP251TP	365015	CECN10
500343	EP60	507067	EP253	510693	EP04	507066	EP252NT	507065	EP251TP	365014	CECN12
500337	EP100	507072	EP753	510693	EP04	507071	EP752NT	507096	EP751TP	365014	CECN12
500338	EP100C	507072	EP753	510693	EP04	507071	EP752NT	507070	EP751TPC	365014	CECN12

Passend für IME/Omniwash

