



Wasch- und Nachspülssysteme

Seite 22



Diverses und Luftfallen

Seite 27



Ablauf- und Filtersysteme

Seite 28



Tür- und Haubenmechanik

Seite 30



Elektrokomponenten

Seite 32



Dosiertechnik

Seite 35



Heizkörper und Boiler

Seite 35



Pumpen und Ersatzteile

Seite 38

## A Wasch- und Nachspülsysteme

Passend für Aristarco



Abb.	Best.-Nr.	Beschreibung	Geräte-Typ	Vergl.-Nr.
1	508111	Wascharm	Gemini CR,	2402
2	508075	Nachspülarm	Programm 25CR	1795



Abb.	Best.-Nr.	Beschreibung	Geräte-Typ	Ver.-Nr.
1	508063	Endkappe Wascharm	Gemini CR, Programm 25CR	1692
2	508056	Endkappe Nachspülarm		1223
3	508078	O-Ring		1826

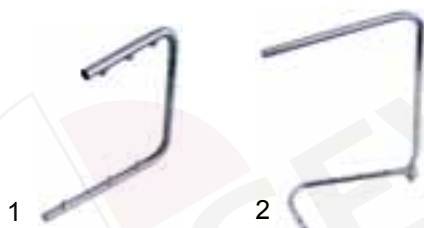

Abb.	Best.-Nr.	Beschreibung	Geräte-Typ	Vergl.-Nr.
1	508017	Dichtung	Gemini CR, Program 25CR	124
2	508361	Befestigungsmutter Nachspülarm		125
3	508051	Doppelkonus		1183
4	508052	Überwurfmutter		1184



Abb.	Best.-Nr.	Beschreibung	Geräte-Typ	Vergl.-Nr.
1	508253	Nachspüldüse	Gemini CR, Programm 25CR	4359
2	508079	Waschdüse		1832



Abb.	Best.-Nr.	Beschreibung	Geräte-Typ	Vergl.-Nr.
1	508076	Wascharmhalter	Gemini CR, Programm 25CR	1796
2	508061	O-Ring		1633
3	508064	Gegenhalter		1695
4	508016	O-Ring		123
5	508077	Schraube		1797



Abb.	Best.-Nr.	Beschreibung	Geräte-Typ	Vergl.-Nr.
1	508042	Korbhalter	Gemini CR, Programm 25CR	631
2	508341	Drehteller		179011
3	508073	Drehtellerlager kpl.		1724
4	508020	Festhaltestift		157



Abb.	Best.-Nr.	Beschreibung	Geräte-Typ	Vergl.-Nr.
1	508242	Wascharm unten	Passport 35.21	4132
2	508244	Wascharm unten/ oben	Passport 38.25 Passport 40.28 Compact 20 Master 22	4160
3	508299	Wascharm oben	Aliseo 422, 428	5010
4	508296	Wascharm unten	Aliseo 422, 428	4986

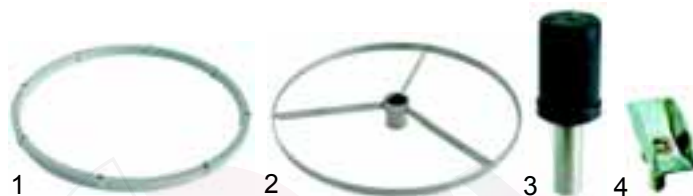

Abb.	Best.-Nr.	Beschreibung	Geräte-Typ	Vergl.-Nr.
1	508245	Wascharm oben/ unten	Passport 45.30	4162
2	508247	Wascharm oben/ unten	Passport 50.30 (Gläser)	4164
3	508246	Wascharm oben/ unten	Passport 50.30 (Teller)	4163



Abb.	Best.-Nr.	Beschreibung	Geräte-Typ	Ver.-Nr.
1	508243	Nachspülarm kpl.	Passport 35.21, Compact 20, Master 22	4133
2	508255	Nachspülarm kpl.	Gemini CF, Program 25 CF, Master21, Minibar CF	4376 1712
3	508265	Wascharm unten	Gemini CF, Program 25CF, Master21, Minibar CF, Project 28	4724 2762

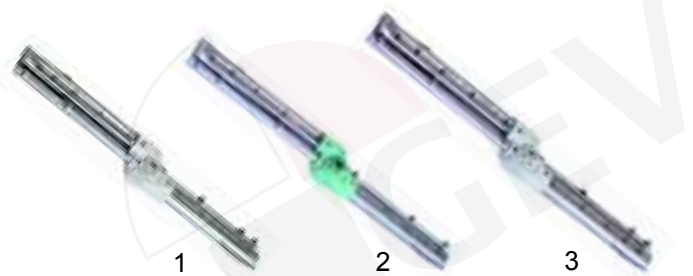

Abb.	Best.-Nr.	Beschreibung	Geräte-Typ	Ver.-Nr.
1	508212	Wascharm oben/unten	AL50.34E (Teller)	3048 4720
2	508211	Wascharm oben/unten	AL50.34E (Gläser)	3021 5051

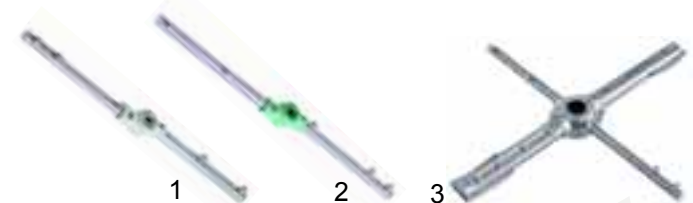

Abb.	Best.-Nr.	Beschreibung	Geräte-Typ	Ver.-Nr.
1	508216	Wascharm oben/unten	Passport 55.40 Passport 10.40	3087 4841
2	508323	Wascharm oben/unten	AL 55.45E	6471 6472



Abb.	Best.-Nr.	Beschreibung	Geräte-Typ	Ver.-Nr.
1	508172	Wascharm (Teller)	GL1040	2757
1	508174	Wascharm (Gläser)		2759
2	508173	Wascharm (Teller)	GL1240	2758
2	508175	Wascharm (Gläser)		2760
3	508177	Nachspülarm	GL1040, GL1240	2761



Abb.	Best.-Nr.	Beschreibung	Geräte-Typ	Ver.-Nr.
1	508112	Rändelmutter	GL1040, GL1240	2416
2	508114	Buchse		2414
3	508113	Nachspülrohr		2417

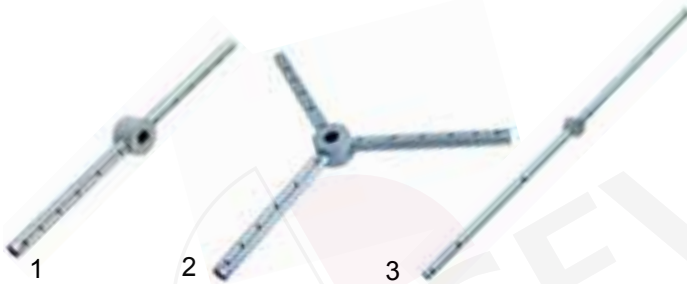

Abb.	Best.-Nr.	Beschreibung	Geräte-Typ	Vergl.-Nr.
1	508008	O-Ring Wascharm	Universal	93
2	508145	Endkappe Wascharm		2650
3	508146	Feder		2654
4	508125	O-Ring Nachspülarm		2531
5	508122	Endkappe Nachspülarm		2502
6	508253	Nachspüldüse		4359
6	508062	Nachspüldüse (alt)		1669



Abb.	Best.-Nr.	Beschreibung	Geräte-Typ	Ver.-Nr.
1	508115	Wascharmbuchse	GL1040, GL1240	2445
2	508104	Wascharmbuchse	Universal	2265
3	508047	Rändelschraube	Universal	1133, 4374



Abb.	Best.-Nr.	Beschreibung	Geräte-Typ	Ver.-Nr.
1	508082	Wascharmkreuz		1954
2	508083	Nachspülarmkreuz		1955



Abb.	Best.-Nr.	Beschreibung	Geräte-Typ	Ver.-Nr.
1	508227	Wascharm 137mm		3195
2	508230	Wascharm 157mm		3198
3	508234	Wascharm 192mm		4001
4	508238	Wascharm 217mm (Teller)		4005
5	508237	Wascharm 217mm (Gläser)		4004



Abb.	Best.-Nr.	Beschreibung	Geräte-T.	Ver.-Nr.
1	508228	Nachspülarm 150mm (2 Düsen)		3196
2	508229	Nachspülarm 150mm (3 Düsen)		3197
3	508231	Nachspülarm 170mm (2 Düsen)		3199
4	508233	Nachspülarm 170mm (3 Düsen)		4000
5	508235	Nachspülarm 205mm (3 Düsen)		4002
6	508236	Nachspülarm 205mm (3 Düsen)		4003
7	508239	Nachspülarm 232mm (3 Düsen)		4006
8	508240	Nachspülarm 232mm (3 Düsen)		4007

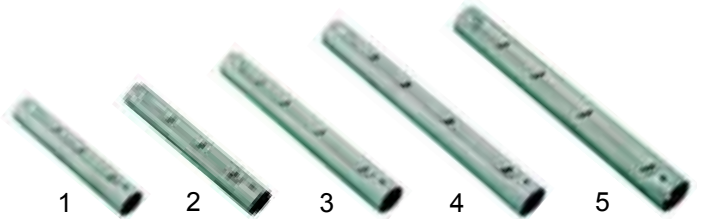

Abb.	Best.-Nr.	Beschreibung	Geräte-Typ	Ver.-Nr.
1	508033	Waschdüse innen (Teller)	GL500CF/CR	213
2	508034	Waschdüse außen (Teller)	GL700 CF/CR	214
3	508013	Waschdüse innen (Gläser)	GL500 CF GL 700 CF	111
4	508053	Waschdüse außen (Gläser)		1186
5	508062	Nachspüldüse		1669
6	508037	Nachspüldüse innen	GL500CF/CR	242
7	508036	Nachspüldüse außen	GL700 CF/CR	241

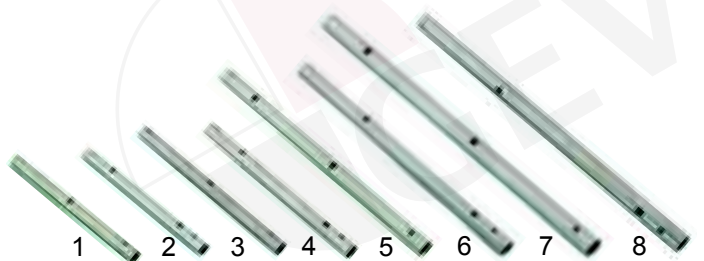

Abb.	Best.-Nr.	Beschreibung	Geräte-Typ	Ver.-Nr.
1	508079	Waschdüse	Gemini CR (alt), Program 25CR (alt), Minibar ( )	1832
2	508062	Nachspüldüse		1669



Abb.	Best.-Nr.	Beschreibung	Geräte-Typ	Ver.-Nr.
1	508183	Nachspülarmhalter		2797
2	508008	O-Ring	Passport 35.21, Master 21, 22	93
3	508181	Nachspülstift		2790
4	508048	Nachspülarmhalter	Compact 20, Gemini CF, Program 25CF	1171



Abb.	Best.-Nr.	Beschreibung	Geräte-Typ	Ver.-Nr.
1	508049	Teflonscheibe		1173
2	508096	Nachspülstift		2153
3	508257	Distanzscheibe		4671
4	508219	Nachspülrohr	Passport 35.21	3155
5	508258	Abdeckung		4672
6	508061	O-Ring		1633
7	508064	Wascharmhalter unten		1695



Abb.	Best.-Nr.	Beschreibung	Geräte-Typ	Ver.-Nr.
1	508120	Nachspülanschluss		2482
2	508119	Schlauchanschluss	Passport 38.25, Passport 40.28, Passport 45.30,	2481
3	508001	O-Ring		25
4	508095	Waschanschluss	Passport 50.32, Passport 50.35,	2150
5	508061	O-Ring	Passport 55.40, Project p28.E/EM,	1633
6	508178	Scheibe (konisch)	GL 4.32E/EM, AL 55.45E/P	2763
7	508167	Distanzscheibe		2733
8	508096	Nachspülstift		2153
9	508049	Teflonscheibe		1173



Abb.	Best.-Nr.	Beschreibung	Geräte-Typ	Ver.-Nr.
1	508120	Nachspülanschluss		2482
2	508119	Schlauchanschluss		2481
3	508001	O-Ring		25
4	508095	Waschanschluss	Aliseo 422, Aliseo 428	2150
5	508303	Distanzscheibe konisch		5113
6	508061	O-Ring		1633
7	508257	Distanzstück		4671
8	508302	Nachspülstift		5110
9	508049	Teflonscheibe		1173



Abb.	Best.-Nr.	Beschreibung	Geräte-Typ	Ver.-Nr.
1	508120	Nachspülanschluss		2482
2	508164	Schlauchanschluss		2730
3	508008	O-Ring		93
4	508143	Distanzstück		2594
5	508161	O-Ring		2713
6	508142	Flansch	GL 1040, GL 1240	2593
7	508109	O-Ring		2374
8	508158	Abdeckung		2710
9	508089	Teflonscheibe		2130
10	508156	Nachspülrohr		2708
11	508197	Scheibe		2914
12	508141	Nachspülstift		2587



Abb.	Best.-Nr.	Beschreibung	Geräte-Typ	Ver.-Nr.
1	508286	Nachspülanschluss	Passport 1040	4923
2	508119	Schlauchanschluss		2481
3	508001	Dichtung		25
4	508095	Wascharmhalter oben		2150
5	508061	Dichtung		1633
6	508287	Abdeckung		4925
7	508289	Nachspülrohr		4927
8	508162	Scheibe		2718
9	508096	Nachspülstift		2153
10	508049	Teflonscheibe		1173



Abb.	Best.-Nr.	Beschreibung	Geräte-Typ	Ver.-Nr.
1	508049	Teflonscheibe	Passport 38.25, Passport 40.28	1173
2	508096	Nachspülstift		2153
3	508257	Distanzstück		4671
4	508220	Nachspülrohr		3156
5	508258	Abdeckung		4672
6	508061	O-Ring		1633
7	508094	Wascharmhalter unten		2149
8	508001	Dichtung		25
9	508180	Nachspülanschluss		2789
10	508119	Schlauchanschluss		2481



Abb.	Best.-Nr.	Beschreibung	Geräte-Typ	Ver.-Nr.
1	508049	Teflonscheibe	Passport 35.21	1173
2	508096	Nachspülstift		2153
3	508257	Distanzstück		4671
4	508219	Nachspülrohr		3155
5	508258	Abdeckung		4672
6	508061	O-Ring		1633
7	508064	Wascharmhalter unten		1695
8	508016	O-Ring		123
9	508179	Schlauchanschluss		2788



Abb.	Best.-Nr.	Beschreibung	Geräte-Typ	Ver.-Nr.
1	508049	Teflonscheibe	Passport 45.30	1173
2	508096	Nachspülstift		2153
3	508257	Distanzstück		4671
4	508097	Nachspülrohr		2154
5	508259	Abdeckung		4673
6	508061	O-Ring		1633
7	508094	Wascharmhalter unten		2149
8	508001	Dichtung		25
9	508180	Nachspülanschluss		2789
10	508119	Schlauchanschluss		2481

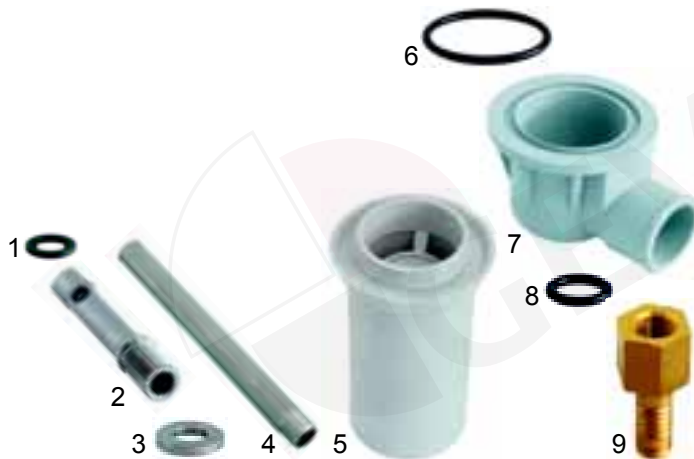

Abb.	Best.-Nr.	Beschreibung	Geräte-Typ	Ver.-Nr.
1	508049	Teflonscheibe	Passport 50.32 Passport 50.35	1173
2	508096	Nachspülstift		2153
3	508257	Distanzstück		4671
4	508206	Nachspülrohr		2991
5	508260	Abdeckung		4674
6	508061	O-Ring		1633
7	508094	Wascharmhalter unten		2149
8	508001	Dichtung		25
9	508180	Nachspülanschluss		2789
10	508119	Schlauchanschluss		2481



Abb.	Best.-Nr.	Beschreibung	Geräte-Typ	Ver.-Nr.
1	508049	Teflonscheibe	Passport 1040	1173
2	508096	Nachspülstift		2153
3	508162	Distanzstück		2718
4	508288	Nachspülrohr		4926
5	508285	Abdeckung		4920
6	508061	O-Ring		1633
7	508094	Wascharmhalter unten		2149
8	508001	Dichtung		25
9	508180	Nachspülanschluss		2789
10	508119	Schlauchanschluss		2481



Abb.	Best.-Nr.	Beschreibung	Geräte-Typ	Ver.-Nr.
1	508049	Teflonscheibe	Passport 50.40 GL5.34, GL7.38	1173
2	508096	Nachspülstift		2153
3	508162	Distanzstück		2718
4	508206	Nachspülrohr		2991
5	508208	Abdeckung		2993
6	508061	O-Ring		1633
7	508094	Wascharmhalter unten		2149
8	508001	Dichtung		25
9	508180	Nachspülanschluss		2789
10	508119	Schlauchanschluss		2481



Abb.	Best.-Nr.	Beschreibung	Geräte-Typ	Ver.-Nr.
1	508049	Teflonscheibe	Compact 20, Master 21, Master 22, Gemini CF, Program 25CF, Minibar CF	1173
2	508066	Nachspülstift		1697
3	508167	Distanzstück		2733
4	508178	Distanzscheibe konisch		2763
5	508061	O-Ring		1633
6	508064	Wascharmhalter unten		1695
7	508016	O-Ring		123
8	508106	Nachspülanschluss		2294
9	508179	Nachspülanschluss		2788



Abb.	Best.-Nr.	Beschreibung	Geräte-Typ	Ver.-Nr.
1	508049	Teflonscheibe	Project 28E/EM, GL4.32E/EM	1173
2	508096	Nachspülstift		2153
3	508162	Distanzstück		2718
4	508097	Nachspülrohr		2154
5	508192	Abdeckung		2870
6	508061	O-Ring		1633
7	508094	Wascharmhalter unten		2149



Abb.	Best.-Nr.	Beschreibung	Geräte-Typ	Ver.-Nr.
1	508049	Teflonscheibe	AL50.34E, AL50.40E	1173
2	508096	Nachspülstift		2153
3	508162	Distanzstück		2718
4	508316	Nachspülrohr		6391
5	508317	Abdeckung		6392
6	508061	O-Ring		1633
7	508094	Wascharmhalter unten		2149



Abb.	Best.-Nr.	Beschreibung	Geräte-Typ	Ver.-Nr.
1	508089	Teflonscheibe		2130
2	508141	Nachspülrohr		2587
3	508197	Scheibe		2914
4	508157	Abdeckung		2709
5	508109	O-Ring	GL1040,	2374
6	508142	Flansch	GL1240	2593
7	508161	O-Ring		2713
8	508155	Nachspülrohr		2707
9	508148	O-Ring		2662
10	508001	Dichtung		25
11	508199	Schlauchanschluss		2921

## Diverses



Abb.	Best.-Nr.	Beschreibung	Geräte-Typ	Ver.-Nr.
1	508241	4 Wege-Verbinders (1 Weg geschlossen)		4120, 4807 4808, 4810 4941, 4943 4938, 4942 2793, 2911
2	508123	T-Stück Dosiergerät		2503
3	508116	Überwurfmutter		2450



Abb.	Best.-Nr.	Beschreibung	Geräte-Typ	Ver.-Nr.
1	508060	Schlauchanschluss 3/8"-12		1387
2	508344	Verteiler		214711



Abb.	Best.-Nr.	Beschreibung	Geräte-Typ	Ver.-Nr.
1	508049	Teflonscheibe		1173
2	508302	Nachspülstift		5110
3	508257	Scheibe		4671
4	508277	Nachspülrohr	Aliseo 422,	4756
5	508304	Abdeckung	Aliseo 428	5114
6	508061	O-Ring		1633
7	508094	Wascharmhalter unten		2149
8	508118	Druckschlauch		2480
9	508278	Reduzierstück		4760



Abb.	Best.-Nr.	Beschreibung	Geräte-Typ	Ver.-Nr.
1	516101	Rücksaugverhinderer		2376, 4731, 4732, 4735, 2802, 4804, 4733, 4734, 4070
2	508215	Dichtung außen		3086
3	508016	Dichtung innen		123

## Luftfallen



Abb.	Best.-Nr.	Beschreibung	Geräte-Typ	Ver.-Nr.
1	508202	Luftfalle		2932
2	508204	Dichtung		2934
3	508200	Mutter		2924
4	508201	Schlauchbogen		2927
5	508203	Verstärkungsrohr		2933



Abb.	Best.-Nr.	Beschreibung	Geräte-Typ	Ver.-Nr.
1	508096	Nachspülstift		2153
2	508162	Scheibe		2718
3	508252	Nachspülrohr	AL 55.45E,	4218
4	508251	Abdeckung	AL 55.45E/P	4217
5	508061	O-Ring		1633
6	508094	Wascharmhalter unten		2149

**A**
**Passend für Aristarco**

Abb.	Best.-Nr.	Beschreibung	Geräte-Typ	Ver.-Nr.
1	508030	Luftfalle	Program 25CF/CR, Minibar CF/CR	206
2	508059	Luftfalle	Master 21, GL500-700	1349
3	508031	Dichtung		207
4	520231	Mutter M10x1		267



Abb.	Best.-Nr.	Beschreibg.	Geräte-Typ	Ver.-Nr.
1	508103	Überlaufrohr	Compact 20, Master 21, 22,	2199
2	508012	Ablaufventil	Minibar CF/CR, Gemini CF/CR,	110
3	508011	Dichtung	Program 25CF/CR,	109
4	508010	Ablaufbogen	Aliseo 422/428	108

## Ablauf- und Filtersysteme



Abb.	Best.-Nr.	Beschreibung	Geräte-Typ	Ver.-Nr.
1	508249	Überlaufrohr	Passport 35.21/ 38.25/	4183
2	508105	Überlaufrohr CNS	40.28/ 45.30, Project 28, GL4.32, GL534, GL738	2274
3	508250	Überlaufrohr	Passport 50.32/ 50.35	4184
4	508207	Überlaufrohr CNS		2992



Abb.	Best.-Nr.	Beschreibung	Geräte-Typ	V.-Nr.
1	508117	Ablaufventil/ Unterteil	Program 25CF	2478
2	508022	Gummiformschlauch	Compact 20	161

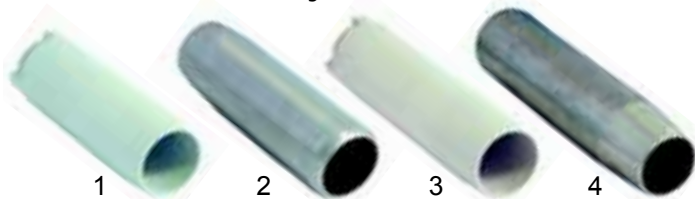

Abb.	Best.-Nr.	Beschreibung	Geräte-Typ	Ver.-Nr.
1	508305	Überlaufrohr	Passport 55.40	5669
2	508152	Überlaufrohr	Passport 1040, GL1040, GL1240	2704
3	508333	Überlaufrohr	AL 50.34E, AL 50.40E	9070
4	508336	Überlaufrohr	AL 55.45	9113



Abb.	Best.-Nr.	Beschreibung	Geräte-Typ	Ver.-Nr.
1	508309	Ablauffilter	Passport 45.30	6279
2	508308	Ablauffilter	Passport 50.30/ 50.35	6278
3	508310	Ablauffilter	Passport 50.40	6280



Abb.	Best.-Nr.	Beschreibung	Geräte-Typ	Ver.-Nr.
1	508002	Ablaufventil		32
2	508029	Dichtung		204
3	508028	Mutter		203



Abb.	Best.-Nr.	Beschreibung	Geräte-Typ	Ver.-Nr.
1	508318	Ablauffilter	AL 50.34E, AL 50.40E	6398
2	508319	Ablauffilter	AL 55.45E	6434





Abb.	Best.-Nr.	Beschreibung	Geräte-Typ	Ver.-Nr.
1	508217	Ansaugfilter	Passport 35.21/ 38.25/ 40.28	3113
2	508226	Spülsieb		3169
3	508263	Ansaugfilter (Teller)	Passport 45.30/ 50.32/ 50.35/ 55.40/ 1040, Project 28, GL4.32, GL1040, GL1240	4721 43
4	508264	Ansaugfilter (Gläser)	Passport 50.32, Project 28, GL432	4722 114



Abb.	Best.-Nr.	Beschreibung	Geräte-Typ	Ver.-Nr.
1	508297	Filter	Aliseo 422, 428	4995
2	508293	Ansaugfilter		4954



Abb.	Best.-Nr.	Beschreibung	Geräte-Typ	Ver.-Nr.
1	508194	Rändelmutter	Passport 45.30, 50.32, 50.35, 55.40, 1040, Project 28, GL4.32, GL1040, GL1240	2901
2	508195	Scheibe		2904
3	508014	Seegering		113
4	508193	Befestigungsstift		2900
5	508108	Ansaugventil	Passport 45.30, 50.32, 50.35, 55.40, 1040, Project 28, GL4.32	2373
6	508109	O-Ring		2374
7	508107	Mutter		2362

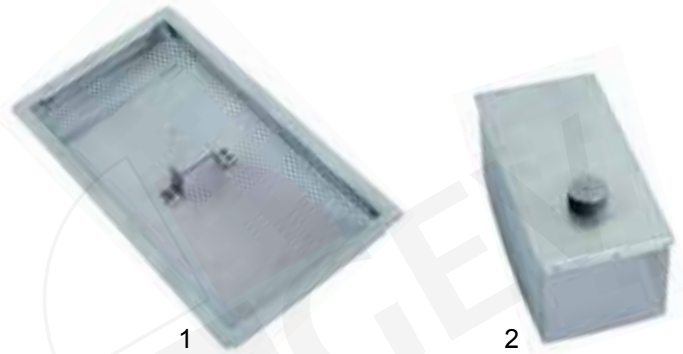

Abb.	Best.-Nr.	Beschreibung	Geräte-Typ	Ver.-Nr.
1	508194	Rändelmutter		2901
2	508195	Scheibe		2904
3	508014	Seegering		113
4	508292	Befestigungsstift	Aliseo 422, 428	4953
5	508291	Schraube		4948
6	508329	Ansaugventil Oberteil		7990
7	508061	Dichtung		1633
8	508064	Ansaugventil Unterteil		1695



Abb.	Best.-Nr.	Beschreibung	Geräte-Typ	Ver.-Nr.
1	508081	Ansaugventil		1933
2	508129	Dichtung		2564
3	508126	Ansauganschluss		2541



Abb.	Best.-Nr.	Beschreibung	Geräte-Typ	Ver.-Nr.
1	508331	Filter	Passport 55.40	8857
2	508150	Filter	Passport 1040, GL1040, GL1240	2701



Abb.	Best.-Nr.	Beschreibung	Geräte-Typ	Ver.-Nr.
1	508050	Ansaugfilter	Gemini CF/CR	1177
2	508018	Ansaugfilter	Compact 20	137

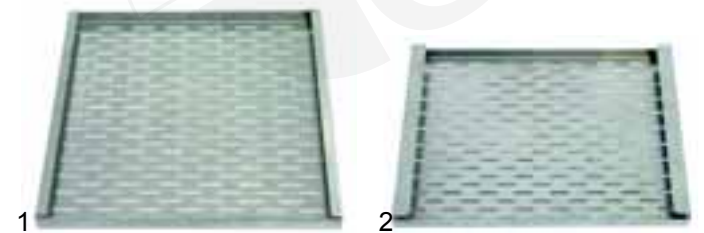

Abb.	Best.-Nr.	Beschreibung	Geräte-Typ	Ver.-Nr.
1	508311	Filter	AL50.34E AL50.40E	6341
2	508335	Filter	AL55.45E	9105

## A Saug- und Druckschläuche

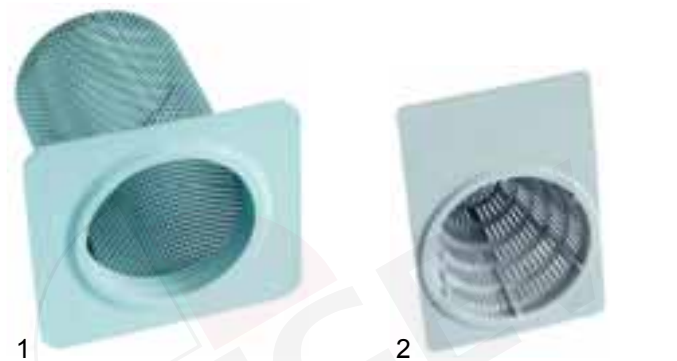

Abb.	Best.-Nr.	Beschreibung	Geräte-Typ	Ver.-Nr.
1	508214	Saugschlauch	Passport 35.21, 38.25, 40.28	3080
2	508092	Druckschlauch	Passport 35.21	2139
3	508248	Druckschlauch	Passport 38.25, 40.28	4171



Abb.	Best.-Nr.	Beschreibung	Geräte-Typ	Ver.-Nr.
1	508147	Saugschlauch	Passport 45.30, 50.32, 50.35, 50.40, 1040, GL4.32	2655
2	508205	Druckschlauch	Passport 45.30, 50.32, 50.35, 50.40, GL4.32	2962
3	508290	Druckschlauch	Passport 1040	4935



Abb.	Best.-Nr.	Beschreibung	Geräte-Typ	Ver.-Nr.
1	508093	Dichtring	Compact 20, Master	2140
2	508092	Druckschlauch		2139
3	508046	Dichtring	Gemini CF, Program 25	706
4	508045	Druckschlauch	CF/LR	700



Abb.	Best.-Nr.	Beschreibung	Geräte-Typ	Ver.-Nr.
1	508147	Saugschlauch	Project 28E	2655
2	508099	Druckschlauch		2157

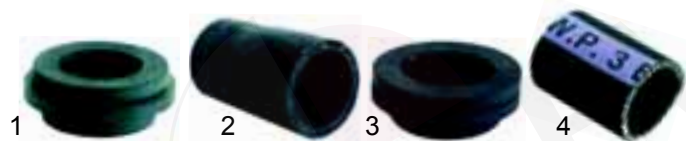

Abb.	Best.-Nr.	Beschreibung	Geräte-Typ	Ver.-Nr.
1	508325	Saugschlauch	AL 55.45E/P	6534
2	508327	Saugschlauch	AL 50.34E, AL 50.40E	6544
3	508205	Druckschlauch	AL 50.34, AL50.40E, AL 55.45E/P	2962



Abb.	Best.-Nr.	Beschreibung	Geräte-Typ	Ver.-Nr.
1	508128	Saugschlauch	GL1040, GL1240	2549
2	508166	Druckschlauch		2732



Abb.	Best.-Nr.	Beschreibung	Geräte-Typ	Ver.-Nr.
1	508295	Saugschlauch	Aliseo 422, 428	4985
2	508294	Druckschlauch		4984



Abb.	Best.-Nr.	Beschreibung	Geräte-Typ	Ver.-Nr.
1	508118	Druckschlauch oben	Passport 38.25, Passport 40.28, Passport 45.30	2480
2	508213	Druckschlauch oben	Passport 50.32, Passport 50.35, Passport 55.40, Passport 1040	3072
3	508165	Druckschlauch oben	GL 1040 (alt), GL1240 (alt)	2731

## Türmechanik



Abb.	Best.-Nr.	Beschreibung	Geräte-Typ	Ver.-Nr.
1	508275	Türstange	Passport 35.21,	4744
2	508223	Buchse	Passport 38.25,	3165
3	508222	Mutter	Passport 40.28,	3164
4	508362	Tropfensammler	Passport 45.30,	4438
5	508198	Gleitplatte	Passport 50.32,	2919
6	508256	Anschlagscheibe	Project 28E/EM, GL4.32,	4609
7	508225	Scharnierstift	Aliseo 422/428	3167



Abb.	Best.-Nr.	Beschreibung	Geräte-Typ	Ver.-Nr.
1	508276	Türstange	Passport 55.40	4745
2	508223	Buchse		3165
3	508224	Stift		3166
4	508362	Tropfensammler		4438
5	508198	Gleitplatte		2919
6	508256	Anschlagscheibe		4609
7	508225	Scharnierstift		3167



Abb.	Best.-Nr.	Beschreibung	Geräte-Typ	Ver.-Nr.
1	508072	Federhalter	Compact 20, Gemini CF/CR, Minibar CF/CR	1723
2	508071	Feder		1722
3	508124	Federhalter		2508
4	508070	Türstift		1715
5	508069	Türstift		Compact 20, Gemini CF/CR, Minibar CF/CR, Master 21/22, Program CF/CR

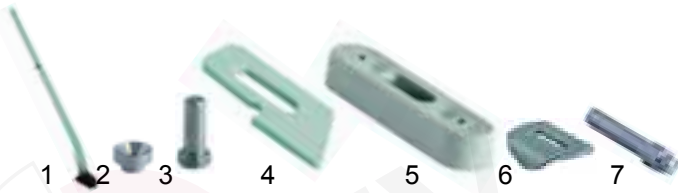

Abb.	Best.-Nr.	Beschreibung	Geräte-Typ	Ver.-Nr.
1	508313	Türbolzen rechts	AL 50.34E, AL 50.40E, AL 55.45E/EP	6370
2	508314	Türbolzen links		6371
3	508321	O-Ring		6456
4	508315	Feder		6377
5	508324	Tropfensammler		6473



Abb.	Best.-Nr.	Beschreibung	Geräte-Typ	Ver.-Nr.
1	508102	Verschluss kpl.		2194
2	508360	Mutter		897
3	508057	Stosskappe		1272
4	508339	Kappe rechts		126011
5	508338	Kappe links		126010



Pos.	Best.-Nr.	Beschreibung	Geräte-Typ	Ver.-Nr.
1	508307	Moosgummi selbstklebend 15x4mm		6143

## Haubenmechanik



Abb.	Best.-Nr.	Beschreibung	Geräte-Typ	Ver.-Nr.
1	508153	Griff	Passport 1040, GL 1040, GL 1240	2705
2	508154	Welle		2706
3	508127	Feder		2543



Abb.	Best.-Nr.	Beschreibung	Geräte-Typ	Ver.-Nr.
1	508132	Buchsenscheibe	Passport 1040, GL 1040, GL 1240	2577
2	508139	Laufbuchse		2585
3	508159	Federträger		2711, 2712, 2832
4	508131	Federscheibe		2576
5	508130	Abstandsrohr für Rolle		2574
6	508140	Wellenbuchse		2586
7	508135	Distanzscheibe		2580
8	508136	Mutter M32x1,5		2581



Abb.	Best.-Nr.	Beschreibung	Geräte-Typ	Ver.-Nr.
1	508137	Mikroschalter-Betätiger		2582
2	508168	Federhalter unten		2738
3	508134	Buchse	Passport 1040, GL 1040, GL 1240	2579
4	508133	Laufrad		2578
5	508138	Anschlag		2583
6	508041	Endkappe		626

## A Elektrokomponenten

### Blenden



Abb.	Best.-Nr.	Beschreibung	Geräte-Typ	Ver.-Nr.
1	508349	Blende	Passport 35.21, Passport 38.25, Passport 40.28	6201
2	508350	Blende	Passport 45.30, Passport 50.32, Passport 50.35, Passport 1040	6202
3	508351	Blende	Passport 55.40	6203



Abb.	Best.-Nr.	Beschreibung	Geräte-Typ	Ver.-Nr.
1	508347	Blende	Compact 20	2464
2	508346	Blende (Laugenpumpe)		2805
3	508363	Blende	Gemini	1688
4	508364	Blende (Laugenpumpe)		1369

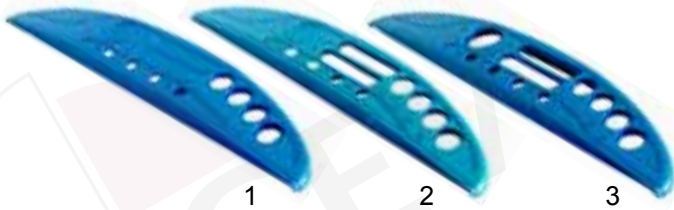

Abb.	Best.-Nr.	Beschreibung	Geräte-Typ	Ver.-Nr.
1	508365	Schalterblende	Program 25CF/LR	8385
2	508357	Schalterblende	Project 28EM, Aliseo 422/428	5000
3	508366	Schalterblende	Project 28E	4248

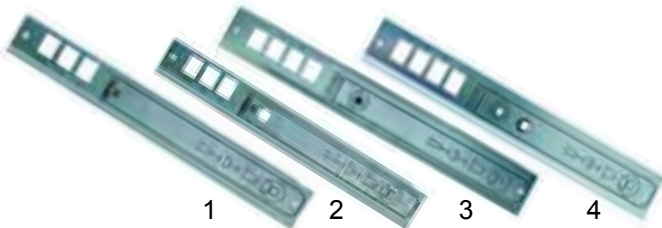

Abb.	Best.-Nr.	Beschreibung	Geräte-Typ	Ver.-Nr.
1	508367	Schalterblende	GL4.32E	4244
2	508348	Folie	GL4.32EM	4776
3	508352	Folie	GL1040, GL1240	5042

### Elektronik

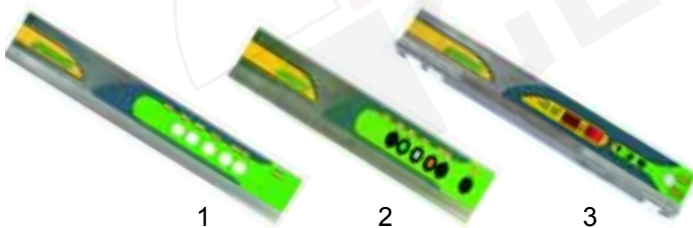

Abb.	Best.-Nr.	Beschreibung	Geräte-Typ	Ver.-Nr.
1	400912	Elektronik	Project 28E, GL 4.32	4104
2	400613	Elektronik	AL 55.45E, AL 50.34E	4435 6478
3	379551	Temperaturfühler		4214, 4122, 4213

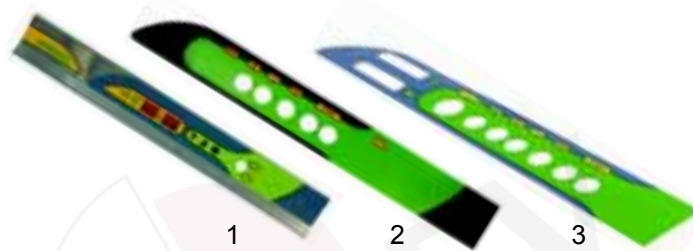
### Schalter



Abb.	Best.-Nr.	Beschreibung	Geräte-Typ	Ver.-Nr.
1	301164	Hauptschalter 0-3 (2-pol.)	Compact 20, Gemini CF/CR, Master 21,	364
2	301162	Taster (2-pol.)	Minibar CF/CR,	1146
3	301166	Signallampe 230V	Program 25 CF/CR, Project 28, GL5.34, GL7.38, GL500, GL700	71

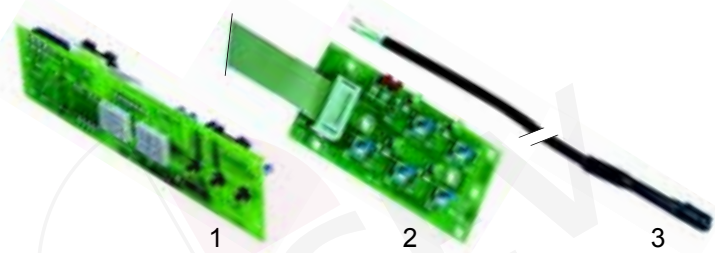

Abb.	Best.-Nr.	Beschreibg.	Geräte-Typ	Ver.-Nr.
1	301165	Umschalter (2-pol.)	Gemini CF/CR, Program 25CF/CR, Project 28, GL5.34, GL7.38, GL500, GL700, GL1040, GL1240	1
2	301163	Taster (2-pol. um)	Master 21, Minibar CF/CR, Gemini CF/CR, Program 25CF/CR	2496



Abb.	Best.-Nr.	Beschreibg.	Geräte-Typ	Ver.-Nr.
1	301174	Schalter (2-pol.)	Passport 35.21/ 38.25/ 40.28/ 45.30/ 50.32/	4042
2	301172	Taster (1-pol.)	50.35/ 55.40/ 1040,	4043
3	508358	Blindkappe Ø20mm	Master 22, Gemini CF/CR	6224



Abb.	Best.-Nr.	Beschreibung	Geräte-Typ	Ver.-Nr.
1	301175	Umschalter (2-pol.)	Program 25CF/CR, Project 28EM, GL4.32EM	4373
2	301173	Taster (2-pol. um)	Aliseo 422, 428	4702

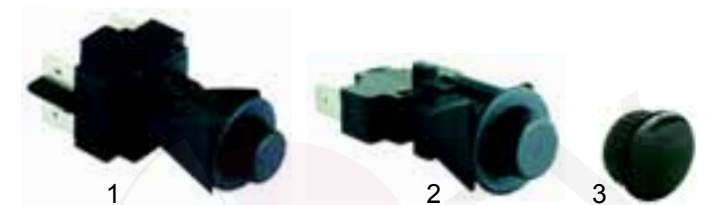

Abb.	Best.-Nr.	Beschreibung	Geräte-Typ	Ver.-Nr.
1	359136	Signallampe 230V grün	Passport 35.21/38.25/40.28/45.30/50.32/50.35/55.40/1040	6207
2	359137	Signallampe 230V gelb		6206
3	359134	Signallampe 230V klar		6204
4	nml	Blindkappe Ø9mm		6225



Abb.	Best.-Nr.	Beschreibung	Geräte-Typ	Ver.-Nr.
1	359788	Signallampe 230V grün	Master 22, Gemini CF/CR, Program 25 CF/CR, GL4.32EM, GL1040, GL1240	4091
2	359789	Signallampe 230V gelb		4090
3	359790	Signallampe 230V klar		4092
4	359791	Signallampe 230V grün	Compact 20, Gemini CF/CR, Program 25 CF/CR	1083



Abb.	Best.-Nr.	Beschreibung	Geräte-Typ	Ver.-Nr.
1	301167	Stellungswähler kpl.		4452
2	301168	Stellungswähler 3 Schließer	Passport 55.40,	4453
3	301169	Kontaktblockhalter	GL1040,	4449
4	301171	Kontaktblock 1 Öffner	GL1240	4456
5	301170	Kontaktblock 1 Schließer		4450



Abb.	B.-Nr.	Beschreibg.	Geräte-Typ	V.-Nr.
1	345810	Mikroschalter 1-pol.	Passport 35.21/38.25/40.28, Program 25 CF/CR, Master 21, Project 28E/EM (alt), GL 5.34, GL 7.38	2651
2	345811	Mikroschalter 2-pol.	Passport 45.30/50.32/50.35/55.40, Master 22, Project 28E/EM, Aliseo 422, 428	4159
3	508360	Mutter		897



Abb.	Best.-Nr.	Beschreibung	Geräte-Typ	Ver.-Nr.
1	345254	Mikroschalter 1-pol.	Passport 1040, GL1040, GL1240	2384
2	345041	Mikroschalter 1-pol.	Compact 20, Gemini CF/CR	925
3	345105	Mikroschalter 1-pol.	Compact 20 (alt), Gemini CF/CR (alt), Minibar CF/CR	1689



Pos.	Best.-Nr.	Beschreibung	Geräte-Typ	Ver.-Nr.
1	345812	Mikroschalter 1-pol.	AL 55.E, AL 50.34E	6476

### Timer



Abb.	Best.-Nr.	Beschreibg.	Geräte-Typ	Ver.-Nr.
1	360077	120° 2 Kammern	Compact 20, Gemini CF/CR, Master 21, Minibar CF/CR, Program 25 CF/CR, Project 28, GL500, GL700, GL4.32, GL 7.38, GL1040, GL1240, Passport 35.21/38.25/40.28/45.30/50.32/50.35/1040, Aliseo 422, 428	1623
2	360269	120°, 240°, 360° 5 Kammern	Passport 55.40	4781



Abb.	Best.-Nr.	Beschreibung	Geräte-Typ	Ver.-Nr.
1	360270	60°, 120°, 180°	GL1040, GL1240	5047
2	360268	18' Regenerierung	Universal	1144

## Pressostate

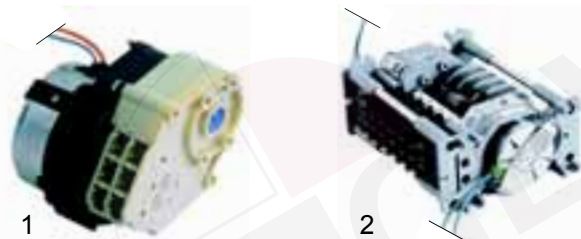

Pos.	Best.-Nr.	Schaltbereich	Geräte-Typ	Ver.-Nr.
1	541140	55/30	Universal	35110
2	541142	123/75	AP1040, GL1040, GL1240, Aliseo 422, Aliseo 428	351

## Thermostate



Abb.	Best.-Nr.	Beschreibung	Geräte-Typ	Ver.-Nr.
1	390421	30°-90°C	Universal	359
2	390006	30°-90°C	Universal (alt)	359
3	110906	Knebel	Universal (alt)	374



Abb.	Best.-Nr.	Beschreibung	Geräte-Typ	Ver.-Nr.
1	390462	Sicherheitsthermostat 105°C Boiler	Universal	4913
2	390461	Sicherheitsthermostat 95°C Tank	Projekt 28, GL4.32, AL 55.40, AL 55.45	4066

## Thermometer

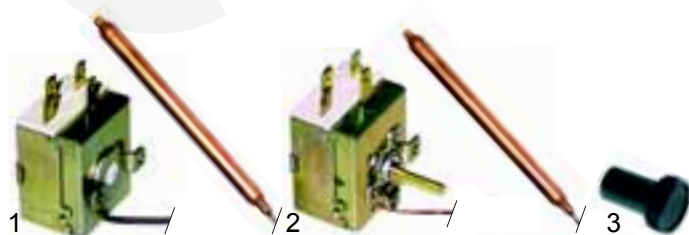

Pos.	Best.-Nr.	Beschreibung	Geräte-Typ	Ver.-Nr.
1	541306	0-120°C/ 3000mm	AP 45.30, AP 50.30, AP 50.35, AP 55.40, AP1040, GL1040, GL1240	5576 5693

## Magnetventile



Abb.	Best.-Nr.	Beschreibung	Geräte-Typ	Ver.-Nr.
1	370248	1fach mit Reduzierung	Universal	394
2	370249	2fach mit Reduzierung	Geräte mit kalter Nachspülung und Enthärter	148

## Relais - Schütze



Abb.	Best.-Nr.	Beschreibung	Geräte-Typ	Ver.-Nr.
1	380307	1-pol. Wechsler 20A	Aliseo 422, 428	4867
2	380312	3-pol. Wechsler 10A	GL1040, GL1240	2300

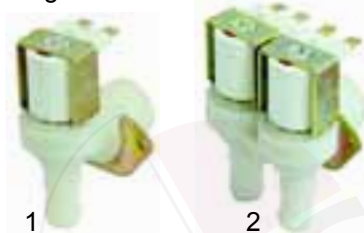

Abb.	Best.-Nr.	Beschreibung	Geräte-Typ	Ver.-Nr.
1	380238	3 Sch. + 1Sch. AC1 20A	AP 35.21, AP 38.25, AP 40.28, AP 45.30, Project 28, GL4.32, GL 5.34, GL 7.38, Aliseo 422, 428	355
2	380213	3 Sch. + 1Sch. AC1 20A	AP 50.32, AP 50.35	5140
3	380204	3 Sch. + 1Sch. AC1 25A	AP 55.40, AP 10.40, GL 1040, GL 1240, AL 55.45, AL 50.34	4375

## Klemmleisten

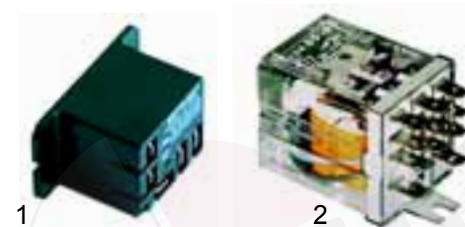

Abb.	Best.-Nr.	Beschreibung	Geräte-Typ	Ver.-Nr.
1	508356	3-pol. 4mm <sup>2</sup>	Compact 20, Gemini, Program 25, Master 21, Minibar, Project	120
2	508353	3-pol. 4mm <sup>2</sup>	AP 35.21, AP 38.25, AP 40.28	921
3	508355	3-pol. 6mm <sup>2</sup>	AP 45.30, Master 22, Project 28, GL 4.32	4251



Abb.	Best.-Nr.	Beschreibung	Geräte-Typ	Ver.-Nr.
1	508354	5-pol. 6mm <sup>2</sup>	AP 50.32, AP 50.35, AP 50.40, AP1040, GL1040, GL1240, Aliseo 422, 428, AL 55.45	891
2	550232	10-pol. 2,5mm <sup>2</sup>	AL 55.45	1488

## Entstörfilter

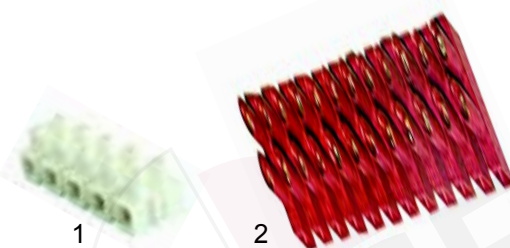

Abb.	Best.-Nr.	Beschreibung	Geräte-Typ	Ver.-Nr.
1	365045	0,47µF (x2) + 0,68MΩ + 2x0,01µF (y2)	Universal	2779
2	365049		Universal	5606

## Dosiertchnik



Abb.	Best.-Nr.	Beschreibung	Geräte-Typ	V.-Nr.
1	361370	Selbstsaugend	Universal	60
2	361369	Reiniger Dosierpumpe 3L/h	Universal	4880



Abb.	Best.-Nr.	Beschreibung	Geräte-Typ	Ver.-Nr.
1	508123	T-Stück		2503
2	508116	Überwurfmutter		2450
3	508326	Rückschlagventil		6535



Abb.	Best.-Nr.	Beschreibung	Geräte-Typ	Ver.-Nr.
1	508301	Wanneneinlauf		5073
2	508306	Wanneneinlauf CNS		5798

## Heizkörper



Abb.	Best.-Nr.	Beschreibung	Geräte-Typ	Ver.-Nr.
1	416244	1000W/230V	Project 28, GL 4.32,	386
1	415145	1500W/230V	AP 50.32, AP 50.35, AP 1040, GL 1040, GL 1240	1350
1	416247	2000W/230V	AP 35.21, AP 38.25, AP 40.28, AP 45.30, AP 55.40, Project 28, GL 4.32	2114
2	415144	2000W/230V	Gemini, Program 25	312
3	415671	1500W/230V	AL 50.34, AL 50.40	200



Abb.	Best.-Nr.	Beschreibung	Geräte-Typ	Ver.-Nr.
1	416248	2000W/230V	AL 55.40	6445T
2	416246	1500W/230V	Project 28, GL 4.32	1595
3	416249	100W/230V	Aliseo 422	4761



Abb.	Best.-Nr.	Beschreibung	Geräte-Typ	Ver.-Nr.
1	415662	2000W/230V	Master 21	2836
2	415166	2000W/230V	AP 35.21, AP 38.25, AP 40.28, Compact 20, Master 22, Gemini, Program 25, Minibar	1324
2	415168	2500W/230V	Project 28, Minibar	1323
3	416245	3000W/230V	AP 45.30, GL 4.32	1294



Abb.	Best.-Nr.	Beschreibung	Geräte-Typ	Ver.-Nr.
1	415146	4500W/230V	AP 50.32, AP 50.35, AP 50.34, AL 50.40, GL1040, GL1240, GL 500, GL 700, GL 5.34, GL 7.38	1299
2	415147	6000W/230V	GL 1040, GL1240	2126

## Zubehör für Heizkörper

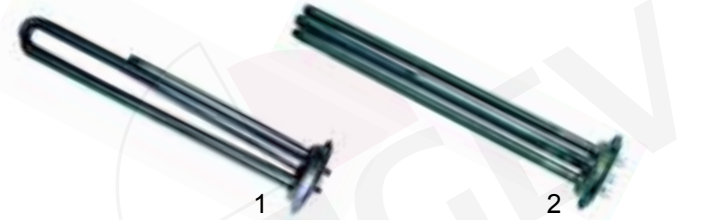

Abb.	Best.-Nr.	Beschreibung	Geräte-Typ	Ver.-Nr.
1	510418	O-Ring	Universal	679
2	520231	Mutter M10x1	Master 21	267
3	508171	Dichtung	Universal	2750
4	521121	O-Ring	Universal	57
5	508080	Flansch	Universal	1871
6	550002	Spannbügel	Universal	1209

## A Boiler

Passend für Aristarco



Abb.	Best.-Nr.	Beschreibung	Geräte-Typ	Ver.-Nr.
1	508221	Boiler 3Liter	Passport 35.21, 38.2-40.28	3161 2486
2	508067	Boiler	Gemini CF/CR, Program 25CF/CR	1699
3	508169	Boiler	Master 21	2745



Abb.	Best.-Nr.	Beschreibung	Geräte-Typ	Ver.-Nr.
1	508209	Boiler	Passport 45.30/ 50.32/ 50.35, GL4.32, AL 50.34, 50.40	2995
2	508281	Boiler 6,5Liter	Passport 55.40, AL 55.45	4839



Abb.	Best.-Nr.	Beschreibung	Geräte-Typ	Ver.-Nr.
1	508261	Boiler	Aliseo 422, Aliseo 428	4686
2	508283	Boiler 8Liter	Passport 1040, GL 1040, GL 1240	4889



Abb.	Best.-Nr.	Beschreibung	Geräte-Typ	Ver.-Nr.
1	508088	Boileranschlussbogen	Passport 55.40, Gemini CF/CR,	2128
2	508051	Dichtung 12mm	Program 25 CF/CR,	1183
3	508052	Überwurfmutter 3/8"	SELF 480, GL500, GL700	1184
4	508016	Dichtung	Master 21	123
5	508149	Schlauchstutzen		2674

## Pumpen

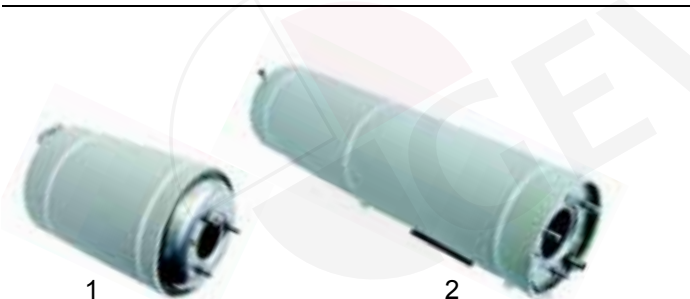
Laugenpumpen/ Drucksteigerungspumpen



Abb.	B.-Nr.	Beschreibung	Geräte-Typ	V.-Nr.
1	500374	Laugenpumpe 230V		379
2	500364	Drucksteigerungspumpe, 230V		380

Waschpumpen



Abb.	Best.-Nr.	Beschreibung	Geräte-Typ	Ver.-Nr.
1	500365	0,10PS/ 230V	Compact 20, Passport 35.21, Master 21, 22, Minibar CF/CR	397
2	500366	0,25PS/ 230V	Gemini CF/CR, Passport 38.25/ 40.28, Program 25 CF/CR, Aliseo 422, 428	1629 4980
3	500372	0,5PS/ 230V	Passport 45.30/ 50.35, Project 28E, GL 4.32	10510 10511



Abb.	Best.-Nr.	Beschreibung	Geräte-Typ	Ver.-Nr.
1	500368	1PS/ 230V	AL 50.34E, GL 5.34 GL 7.38	2868
1	500367	1PS/ 400V	Passport 55.40	5688
2	500369	1PS/ 400V	Passport 1040	4054
2	500370	1PS/ 230V	Passport 1040, AL 5040, AL55.45	4053



Abb.	Best.-Nr.	Beschreibung	Geräte-Typ	Ver.-Nr.
1	500371	1,2PS/ 400V	GL1040, GL 1240	2532
2	500373	1,5PS/ 400V		424



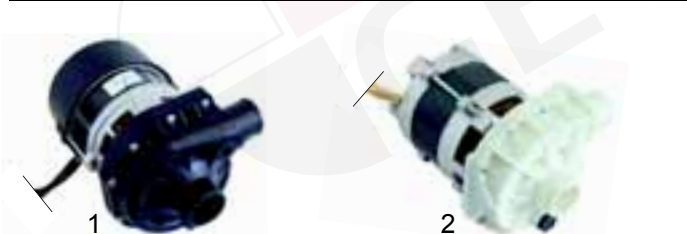

Pumpe		1 Laufrad		2 Gleitringdichtung		3 Gehäusedichtung		4 Pumpendeckel		5 Kondensator	
B.-Nr.	V.-Nr.	B.-Nr.	V.-Nr.	B.-Nr.	V.-Nr.	B.-Nr.	V.-Nr.	B.-Nr.	V.-Nr.	B.-Nr.	V.-Nr.
500365	397	521226	4384	510692	4387	521704	4381	521521	4389	365012	
500366	1629	521233	4385	510693	4388	521728	4382	521529	4379	365015	
500367	5688	521235		510692		512709		521531		-	
500368	2868	509021	4406	510692	4387	521709	4383	521531	4380	365021	
500369	4054	521208		510692		521702		521506		-	
500370	4053	521211		510692		521702		521506		365021	
500371	2532	521231	4399	510693	4388	521711	4398	521532	4396	-	
500373	424	521264	4400	510693	4388	521711	4398	521561	4627		
500372	10511	510623	4386	510692	4387	521709	4384	521531	4626	365014	

