

# Elektroden

# 23

Elektroden Leitwersteuerung.....	682
Niveauelektroden.....	682



# Elektroden

## Elektroden-Leitwertsteuerung

### Bores



Abb.	GEV-Nr.	Einbau ø (mm)	Abb.	GEV-Nr.	Einbau ø (mm)
1	361068	12	2	361414	22

### Meiko



Abb.	GEV-Nr.	Einbau ø (mm)	Abb.	GEV-Nr.	Einbau ø (mm)
1	361245	17	2	361274	17

## Niveauelektroden

### Ambach



Abb.	GEV-Nr.	Befestigungsart	Gesamtlänge (mm)	Fühler L (mm)	Anschluss
1	400130	M14x1,25	220	194	F6,3

### Animo



Abb.	GEV-Nr.	Befestigungsart	Gesamtlänge (mm)	Fühler L (mm)	Anschluss
1	402544	M10	70	40	F6,3

### Aristarco



Abb.	GEV-Nr.	Befestigungsart	Gesamtlänge (mm)	Fühler L (mm)	Anschluss
1	403236	M10x1,5	73	35	M4

### Ascobloc



Abb.	GEV-Nr.	Befestigungsart	Gesamtlänge (mm)	Fühler L (mm)	Anschluss
1	400697	PG16	26	20	M5

### Bourgeois



Abb.	GEV-Nr.	Befestigungsart	Gesamtlänge (mm)	Fühler L (mm)	Anschluss
1	400807	1/2"	112	88	Rundstecker



Abb.	GEV-Nr.	Befestigungsart	Gesamtlänge (mm)	Fühler L (mm)	Anschluss
2	402987	-	325	-	F6,3



Abb.	GEV-Nr.	Befestigungsart	Gesamtlänge (mm)	Fühler L (mm)	Anschluss
3	402986	-	460	-	F6,3

### CoffeeQueen



Abb.	GEV-Nr.	Befestigungsart	Gesamtlänge (mm)	Fühler L (mm)	Anschluss
1	402837	Gewinde	55	38	-

### Comenda



Abb.	GEV-Nr.	Befestigungsart	Gesamtlänge (mm)	Fühler L (mm)	Anschluss
1	403254	M10x1,5	55	30x40	M4

### Convotherm



Abb.	GEV-Nr.	Befestigungsart	Gesamtlänge (mm)	Fühler L (mm)	Anschluss
1	400076	1/2"	190	125/155	Rundstecker



Abb.	GEV-Nr.	Befestigungsart	Gesamtlänge (mm)	Fühler L (mm)	Anschluss
2	400075	1/2"	270	185/235	Rundstecker



Abb.	GEV-Nr.	Befestigungsart	Gesamtlänge (mm)	Fühler L (mm)	Anschluss
3	401869	Schraubflansch	185	160/30	Rundstecker

### Cookmax



Abb.	GEV-Nr.	Befestigungsart	Gesamtlänge (mm)	Fühler L (mm)	Anschluss
1	402104	Schraubflansch	175	155/115/90/60/45/30	F2,8

### Electrolux



Abb.	GEV-Nr.	Befestigungsart	Gesamtlänge (mm)	Fühler L (mm)	Anschluss
1	400405	1/4"	345	320	F6,3



Abb.	GEV-Nr.	Befestigungsart	Gesamtlänge (mm)	Fühler L (mm)	Anschluss
2	400124	steckbar	128	103	F6,3



Abb.	GEV-Nr.	Befestigungsart	Gesamtlänge (mm)	Fühler L (mm)	Anschluss
3	401548	steckbar	175	151	F6,3

### Elframo



Abb.	GEV-Nr.	Befestigungsart	Gesamtlänge (mm)	Fühler L (mm)	Anschluss
1	403263		75		
1	403264		125		

### Emmepi



Abb.	GEV-Nr.	Befestigungsart	Gesamtlänge (mm)	Fühler L (mm)	Anschluss
1	400021	PG9	110	70/47/24	Klemmanschluss
1	400022	PG9	135	89/59/28	Klemmanschluss

### Fagor



Abb.	GEV-Nr.	Befestigungsart	Gesamtlänge (mm)	Fühler L (mm)	Anschluss
1	400163	PG9	100	72/43/22	Klemmanschluss



Abb.	GEV-Nr.	Befestigungsart	Gesamtlänge (mm)	Fühler L (mm)	Anschluss
2	400021	PG9	110	70/47/24	Klemmanschluss
2	400022	PG9	135	89/59/28	Klemmanschluss



Abb.	GEV-Nr.	Befestigungsart	Gesamtlänge (mm)	Fühler L (mm)	Anschluss
3	400884	steckbar	105	95	M4
3	400885	steckbar	120	110	M4
3	400886	steckbar	130	120	M4

### Falcon



Abb.	GEV-Nr.	Befestigungsart	Gesamtlänge (mm)	Fühler L (mm)	Anschluss
1	403183	3/8"	162	11	M3



Abb.	GEV-Nr.	Befestigungsart	Gesamtlänge (mm)	Fühler L (mm)	Anschluss
2	403143	2-Lochflansch	100	-	M6x1



Abb.	GEV-Nr.	Befestigungsart	Gesamtlänge (mm)	Fühler L (mm)	Anschluss
3	403144	2-Lochflansch	215	116	M6x1

### Gicar



Abb.	GEV-Nr.	Befestigungsart	Gesamtlänge (mm)	Fühler L (mm)	Anschluss
1	401161	1/4"	210	184	F6,3
1	400130	M14x1,25	220	194	F6,3



2



Abb.	GEV-Nr.	Befestigungsart	Gesamtlänge (mm)	Fühler L (mm)	Anschluss
2	400405	1/4"	345	320	F6,3

3



Abb.	GEV-Nr.	Befestigungsart	Gesamtlänge (mm)	Fühler L (mm)	Anschluss
3	401548	steckbar	175	151	F6,3

GIGA

1



Abb.	GEV-Nr.	Befestigungsart	Gesamtlänge (mm)	Fühler L (mm)	Anschluss
1	400130	M14x1,25	220	194	F6,3

Granuldisk

1



Abb.	GEV-Nr.	Befestigungsart	Gesamtlänge (mm)	Fühler L (mm)	Anschluss
1	403322	3/8"	75	46	M4

Groen USA

1



Abb.	GEV-Nr.	Befestigungsart	Gesamtlänge (mm)	Fühler L (mm)	Anschluss
1	403183	3/8"	162	11	M3

Hobart

1



Abb.	GEV-Nr.	Befestigungsart	Gesamtlänge (mm)	Fühler L (mm)	Anschluss
1	402986	-	460	-	F6,3

Hoonved

1 2



Abb.	GEV-Nr.	Befestigungsart	Gesamtlänge (mm)	Fühler L (mm)	Anschluss
1	361385	1/8"	55	40x40	M4
2	361386	1/8"	95	82	M4

3

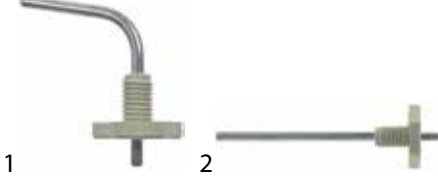

Abb.	GEV-Nr.	Befestigungsart	Gesamtlänge (mm)	Fühler L (mm)	Anschluss
3	512072	1/2"	78,5	63	M5x0,8

Icematic

1



Abb.	GEV-Nr.	Befestigungsart	Gesamtlänge (mm)	Fühler L (mm)	Anschluss
1	403562	steckbar	120	95	F6,3

Inomak

1



Abb.	GEV-Nr.	Befestigungsart	Gesamtlänge (mm)	Fühler L (mm)	Anschluss
1	403296	steckbar	167	115	F6,3

Juno

1



Abb.	GEV-Nr.	Befestigungsart	Gesamtlänge (mm)	Fühler L (mm)	Anschluss
1	400405	1/4"	345	320	F6,3

2



Abb.	GEV-Nr.	Befestigungsart	Gesamtlänge (mm)	Fühler L (mm)	Anschluss
2	400124	steckbar	128	103	F6,3

3



Abb.	GEV-Nr.	Befestigungsart	Gesamtlänge (mm)	Fühler L (mm)	Anschluss
3	401548	steckbar	175	151	F6,3

Krefftt

1



Abb.	GEV-Nr.	Befestigungsart	Gesamtlänge (mm)	Fühler L (mm)	Anschluss
1	400021	PG9	110	70/47/24	Klemmanschluss
1	400022	PG9	135	89/59/28	Klemmanschluss

Küppersbusch

1



Abb.	GEV-Nr.	Befestigungsart	Gesamtlänge (mm)	Fühler L (mm)	Anschluss
1	400072	steckbar	100	90	F6,3
1	400071	steckbar	170	155	F6,3

## Lainox



1

Abb.	GEV-Nr.	Befestigungsart	Gesamtlänge (mm)	Fühler L (mm)	Anschluss
1	400130	M14x1,25	220	194	F6,3

## Lincat



1

Abb.	GEV-Nr.	Befestigungsart	Gesamtlänge (mm)	Fühler L (mm)	Anschluss
1	401912	1/8"	230	225	Rundstecker

## Mach



1

Abb.	GEV-Nr.	Befestigungsart	Gesamtlänge (mm)	Fühler L (mm)	Anschluss
1	504138	M10	56	30	Rundstecker

## Marco



1

Abb.	GEV-Nr.	Befestigungsart	Gesamtlänge (mm)	Fühler L (mm)	Anschluss
1	402777	1/4"	140	127	M4

## Mareno



1

Abb.	GEV-Nr.	Befestigungsart	Gesamtlänge (mm)	Fühler L (mm)	Anschluss
1	401161	1/4"	210	184	F6,3

## MBM-Italia



1

Abb.	GEV-Nr.	Befestigungsart	Gesamtlänge (mm)	Fühler L (mm)	Anschluss
1	401161	1/4"	210	184	F6,3

## Meiko



1

Abb.	GEV-Nr.	Befestigungsart	Gesamtlänge (mm)	Fühler L (mm)	Anschluss
1	403314	1/2"	150	125	Rundstecker

## Melitta



1

Abb.	GEV-Nr.	Befestigungsart	Gesamtlänge (mm)	Fühler L (mm)	Anschluss
1	402104	Schraubflansch	175	155/115/90/60/45/30	F2,8

## MKN



1

Abb.	GEV-Nr.	Befestigungsart	Gesamtlänge (mm)	Fühler L (mm)	Anschluss
1	401409	1/4"	132	102	F6,3



2

Abb.	GEV-Nr.	Befestigungsart	Gesamtlänge (mm)	Fühler L (mm)	Anschluss
2	401458	M10x1	132	112	F6,3

## Morice



1

Abb.	GEV-Nr.	Befestigungsart	Gesamtlänge (mm)	Fühler L (mm)	Anschluss
1	403136	M4	150	145	F6,3
1	403135	M4	200	12	F6,3

## Palux



1

Abb.	GEV-Nr.	Befestigungsart	Gesamtlänge (mm)	Fühler L (mm)	Anschluss
1	400697	PG16	26	20	M5



### Pavoni



1

Abb.	GEV-Nr.	Befestigungsart	Gesamtlänge (mm)	Fühler L (mm)	Anschluss
1	402549	1/4"	125	100	F6,3

### Rational



1

Abb.	GEV-Nr.	Befestigungsart	Gesamtlänge (mm)	Fühler L (mm)	Anschluss
1	403138	PG9	100	85	kodierter Stecker



2

Abb.	GEV-Nr.	Befestigungsart	Gesamtlänge (mm)	Fühler L (mm)	Anschluss
2	400163	PG9	100	72/43/22	Klemmanschluss



3

Abb.	GEV-Nr.	Befestigungsart	Gesamtlänge (mm)	Fühler L (mm)	Anschluss
3	400021	PG9	110	70/47/24	Klemmanschluss
3	400022	PG9	135	89/59/28	Klemmanschluss



4

Abb.	GEV-Nr.	Befestigungsart	Gesamtlänge (mm)	Fühler L (mm)	Anschluss
4	403298	M15x1,5	110	85	kodierter Stecker



5

Abb.	GEV-Nr.	Befestigungsart	Gesamtlänge (mm)	Fühler L (mm)	Anschluss
5	403297	M15x1,5	190	165	kodierter Stecker

### Retigo



1

Abb.	GEV-Nr.	Befestigungsart	Gesamtlänge (mm)	Fühler L (mm)	Anschluss
1	403295	M16x1	205	148	3-adrig



2

Abb.	GEV-Nr.	Befestigungsart	Gesamtlänge (mm)	Fühler L (mm)	Anschluss
2	403353	steckbar	225	185	Rundstecker

### Rieber



1

Abb.	GEV-Nr.	Befestigungsart	Gesamtlänge (mm)	Fühler L (mm)	Anschluss
1	401590	PG21	50	10	Klemmanschluss

### Rosinox



1

Abb.	GEV-Nr.	Befestigungsart	Gesamtlänge (mm)	Fühler L (mm)	Anschluss
1	403131	1/4"	330	270	M4



2

Abb.	GEV-Nr.	Befestigungsart	Gesamtlänge (mm)	Fühler L (mm)	Anschluss
2	400171	1/4"	350	325	F6,3



3

Abb.	GEV-Nr.	Befestigungsart	Gesamtlänge (mm)	Fühler L (mm)	Anschluss
3	512072	1/2"	78,5	63	M5x0,8

4

Abb.	GEV-Nr.	Befestigungsart	Gesamtlänge (mm)	Fühler L (mm)	Anschluss
4	400021	PG9	110	70/47/24	Klemmanschluss
4	400022	PG9	135	89/59/28	Klemmanschluss

### Silko



1

Abb.	GEV-Nr.	Befestigungsart	Gesamtlänge (mm)	Fühler L (mm)	Anschluss
1	400171	1/4"	350	325	F6,3

### Therma



1

Abb.	GEV-Nr.	Befestigungsart	Gesamtlänge (mm)	Fühler L (mm)	Anschluss
1	400124	steckbar	128	103	F6,3

### Zanussi



1

Abb.	GEV-Nr.	Befestigungsart	Gesamtlänge (mm)	Fühler L (mm)	Anschluss
1	400124	steckbar	128	103	F6,3

### Wiesheu-Wiwa



1

Abb.	GEV-Nr.	Befestigungsart	Gesamtlänge (mm)	Fühler L (mm)	Anschluss
1	400065	M15x1,5	135	77/67/57	Klemmanschluss

### Zanussi



2

Abb.	GEV-Nr.	Befestigungsart	Gesamtlänge (mm)	Fühler L (mm)	Anschluss
2	401548	steckbar	175	151	F6,3



528544  
528545  
528546  
528547  
528576  
528574  
528573  
528572  
528575

528552  
528556

528579  
528578

528582  
528562

528565

NO-STO



ZUR KASSE

**FILTER**

Anwendungen  
Kaffeemaschine

Produktgruppen  
Druckkomponenten  
Gaskomponenten  
Mechanik und Handhabung  
Wasserleitung  
Werkzeug, Befestigungsmaterialien, Verbrauchsgüter

Geräte  
ATA  
Aster  
Adler  
Amal  
Anbach  
Anbaskade  
Arflex  
Angelo Po  
Anemo  
Asialto  
Ascalini  
Aurora  
SFC  
Bianco  
Bartscher  
Berco  
Bosch

**EXPLOSIONSZEICHNUNGEN**  
jederzeit verfügbar im GEV-Webshop und der App

